

PROMOTIEFOLDER

01/10/2017 - 31/03/2018

Makita[®]
PROFESSIONALS AT WORK



NIEUW

ACCU HAAKSE SLIJPER LXT

DGA900ZK
DGA900PT2

18v + 18v → **36v**



ADT

BL
MOTOR

AFT

INHOUD

p. 3-9 Nieuwigheden

p. 10-24 Promoties

p. 26-60 Accumachines

p. 61-67 Hamers

p. 68-69 Boormachines

p. 70 Bevestigen & Schroeven

p. 71 Metaal

p. 72-74 Slijpers

p. 75-76 Metaal & Beton

p. 77-86 Hout

p. 87 Stofzuigers





























































p. 88 Diversen

p. 89 Generatoren / Compressors

p. 90 Pneumatisch

p. 91 Lasers

p. 92-104 Tuinbouwgereedschap

 Dubbel geïsoleerd	 Instelbaar koppel / aantal posities 16	 Snelspanboorkop met blokkeerpositie	 Laser
 Variabele snelheid	 Instelbaar koppel / aantal posities 18	 Soft Start	 Dial Depth Adjusting
 Elektronische toerenregeling	 Instelbaar koppel / aantal posities 21	 Easy Start	 Auto firing stop
 Elektronische ontsteking	 Veiligheids- / slipkoppeling	 Verstekzagen L45	 Kettingrem
 "Memory Power" Digitale ontsteking	 Stofafzuiging	 Verstekzagen L45 R5	 Automatische kettingsmering
 Scavenging Losses Rejection	 Decompressie klep	 Verstekzagen L+R	 Opvoerpomp
 L+R schakelaar	 SDS-PLUS aansluiting	 Snelstart systeem	 Anti-vibratie systeem
 2 mechanische snelheden	 SDS-MAX aansluiting	 Inschakelautomaat	 360° werking
 3 mechanische snelheden	 SJS systeem	 Draaibare slagaansluiting	 Koffer
 3 elektrische snelheden	 Zeskant opname 30 mm	 Papieren filter	 Houten koffer
 2 elektrische snelheden	 Zeskant opname 28,6 mm	 Inlet filter	 MAK PAC koffer
 Elektrische of mechanische rem	 Zaagbladopname enkelnokkenschacht	 Roestvrije tank	 DXT Deep and Exact Cutting Technology
 Smart Impact Technology	 Pendelbeweging	 FL MOTOR Koolborstelloze gelijkstroommotor	 CXT Compact eXtreme Technology
 Anti-vibratie systeem	 SJS II systeem	 Makita MM4 viertaktmotor	
 Extreme Protection Technology	 HEPA H13 filter	 Single sequential firing	
 Lithium-ion Xtreme Technology	 Lichtfunctie	 Velcro bevestiging	

MAKITA WERKT VOLGENS DE RICHTLIJNEN VAN DE EPTA



EPTA staat voor European Power Tool Association en is een vereniging van de belangrijkste fabrikanten van powertools. De EPTA stelt verplichte richtlijnen op, waardoor uniforme en vergelijkbare specificaties en gegevens gegarandeerd worden. Zo zijn er richtlijnen voor het gewicht (zonder snoer maar met alle machinetoebehoren die voor het normale gebruik noodzakelijk zijn), voor slagkracht, enz.

In het verleden had iedere fabrikant zijn eigen norm, daarom waren de gegevens voor de invoering van EPTA, van fabrikant tot fabrikant verschillend en niet met elkaar vergelijkbaar.

Om u zo correct mogelijk te informeren, meet Makita uitsluitend volgens de richtlijnen van de EPTA. In alle onze media (catalogi, folders, website, enz.) worden daarom enkel waarden conform de EPTA-richtlijnen gebruikt.

ACCU HAAKSE SLIJPER LXT 2 X 18V
DGA900ZK / DGA900PT2

NIEUW



DGA900PT2



ADT De automatische snelheidscontrole zorgt ervoor dat men op elk moment het meest efficiënt slijpt: het toerental wordt automatisch aangepast aan de belasting.

AFT Meer controle door de elektrische motorrem die de machine dadelijk stopt bij loslaten van de schakelaar.

		DGA900ZK	DGA900PT2
Batterijcapaciteit		2 x 18 V	2 x 18 V / 5.0 Ah
Aantal bijgeleverde accu's		0	2 x BL1850B
Maximaal toerental onbelast		6000 t.p.m.	6000 t.p.m.
Diameter slijpschijf		230 mm	230 mm
Heropstartbeveiliging		✓	✓
Gewicht		5,2 kg	5,2 kg
Prijs in €	Excl. BTW		
	Incl. BTW		

TELESCOPISCHE DUBBEL-VERSTEKZAAG
LS1019L

NIEUW



DEAWST06
Onderstel ter
waarde van € 189,00

		LS1019L
Vermogen		1510 W
Ø Zaagblad		260 mm
Gewicht		26,3 kg
Prijs in €	Excl. BTW	
	Incl. BTW	

LIJNLASER

SK209GDZ NIEUW



+ Powerpack
197657-7

		SK209GDZ
Nauwkeurigheid		+/-1 mm / 10 m
Aantal lijnen		3 x groen
Aantal accu's		+ powerpack 10,8V
Gewicht		1,6 kg
Prijs in €	Excl. BTW	
	Incl. BTW	

LIJNLASER

SK312GDZ NIEUW



+ Powerpack
197657-7

		SK312GDZ
Nauwkeurigheid		+/-1 mm / 10 m
Aantal lijnen		3 x groen
Aantal accu's		+ powerpack 10,8V
Gewicht		1,5 kg
Prijs in €	Excl. BTW	
	Incl. BTW	

DRAADSTANGSNIJDER LXT 18V

DSC250ZK **NIEUW**

18V
LITHIUM-ION



BL
MOTOR

ADT

DSC250ZK

Nominale accuspanning	18 V	
Aantal bijgeleverde accu's	0	
Diameter	110 mm	
Maximale snijcapaciteit klasse 40-60	10 - 25 mm	
Gewicht	3,9 kg	
Prijs in €	Excl. BTW	
	Incl. BTW	

VACUÛMPOMP LXT 18V

DVP180Z **NIEUW**

18V
LITHIUM-ION



DVP180Z

Nominale accuspanning	18 V	
Aantal bijgeleverde accu's	0	
Compressietype	Olie roterend (schoepen), eentraps	
Maximum debiet	50 l/min	
Eindvacuüm	20 Pa	
Gewicht	2,9 kg	
Prijs in €	Excl. BTW	
	Incl. BTW	

ACCU KRUIWAGEN LXT 18V

DCU180Z **NIEUW**

18V
LITHIUM-ION



leverbaar
vanaf december

Uitgerust met
LED verlichting (2x)

+ Kuip



Optioneel accessoire :
Buizenframe (199009-8)

DCU180Z

Nominale accuspanning	18 V	
Aantal bijgeleverde accu's	0	
Maximale belastingscapaciteit	130 kg	
Snelheid	voorwaarts: 3.5 km/h achteruit: 1.0 km/h	
Maximale helling	12°	
Prijs in €	Excl. BTW	
	Incl. BTW	

ACCU BOORHAMERS

HR140DSAJ / HR140DSMJ / HR166DSMJ / HR166DWAE1

NIUW



CXT **10.8V**

BL MOTOR **BL MOTOR**

	HR140DSAJ	HR140DSMJ	HR166DSMJ	HR166DWAE1
Batterijcapaciteit	10,8 V / 2,0 Ah	10,8 V / 4,0 Ah	10,8 V / 4,0 Ah	10,8 V / 2,0 Ah
Gemiddelde oplaadtijd	30 min.	60 min.	60 min.	30 min.
Slagenergie	1,0 J	1,0 J	1,1 J	1,1 J
Optimale Ø beton	4 - 8 mm	4 - 8 mm	4 - 10 mm	4 - 10 mm
Aantal accu's	2 x BL1020B	2 x BL1040B	2 x BL1040B	2 x BL1020B
Gewicht	1,9 kg	1,9 kg	1,8 kg	1,8 kg
Prijs in €	Excl. BTW			
	Incl. BTW			

ACCU KITPISTOOL

CG100DZA / CG100DSAE A / CG100DSAE B

NIUW



CXT

10.8V

	CG100DZA	CG100DSAE A	CG100DSAE B
Batterijcapaciteit	10,8 V 2,0 Ah - 4,0 Ah	10,8 V / 2,0 Ah	10,8 V / 2,0 Ah
Gemiddelde oplaadtijd	30 min. / 60 min.	30 min.	30 min.
Maximale extrusiekracht	5000 N	5000 N	5000 N
Maximale extrusiesnelheid	0-28 mm/s	0-28 mm/s	0-28 mm/s
Aantal accu's	0	2 x BL1020B	2 x BL1020B
Prijs in €	Excl. BTW		
	Incl. BTW		

ACCU HAAKSE SLAGSCHROEVENDRAAIERS

TL064DZJ / TL065DZJ

NIEUW

Aansluiting
1/4"



Aansluiting
3/8"



		TL064DZJ	TL065DZJ
Batterijcapaciteit		10,8 V	10,8 V
Gemiddelde oplaadtijd		30 min. / 60 min.	30 min. / 60 min.
Toerental		0-2000 t.p.m.	0-2000 t.p.m.
Aantal accu's		0	0
Gewicht		1,2 kg	1,2 kg
Prijs in €	Excl. BTW		
	Incl. BTW		

ACCU GIPSAAG

SD100DZJ

NIEUW



CXT

10.8V

		SD100DZJ
Batterijcapaciteit		10,8 V
Gemiddelde oplaadtijd		30 min. / 60min.
Slaglengte		6 mm
Aantal accu's		0
Gewicht		1,5 kg
Prijs in €	Excl. BTW	
	Incl. BTW	

ACCU AFWERKINGSPISTOOL

PT354DZJ / PT354DSAJ / PT354DSMJ

NIEUW

CXT

10.8V



PT354DSMJ



		PT354DZJ	PT354DSAJ	PT354DSMJ
Batterijcapaciteit		10,8 V	10,8 V / 2,0 Ah	10,8 V / 4,0 Ah
Gemiddelde oplaadtijd		30 min. / 60 min.	30 min.	60 min.
Draadkaliber		23 Ga	23 Ga	23 Ga
Doorsnede nagel		0,6 mm	0,6 mm	0,6 mm
Lengte nagel		15-35 mm	15-35 mm	15-35 mm
Aantal accu's		0	2 x BL1020B	2 x BL1040B
Gewicht		2,0 kg	2,0 kg	2,0 kg
Prijs in €	Excl. BTW			
	Incl. BTW			

ACCU HAAKSE BOORMACHINES

DA332DSAJ / DA332DSMJ / DA333DSAJ / DA333DSMJ

NIEUW

10.8V

CXT



DA332DSAJ

63 mm



DA333DSMJ

84 mm



		DA332DSAJ	DA332DSMJ	DA333DSAJ	DA333DSMJ
Batterijcapaciteit		10,8 V / 2,0 Ah	10,8 V / 4,0 Ah	10,8 V / 2,0 Ah	10,8 V / 4,0 Ah
Gemiddelde oplaadtijd		30 min.	60 min.	30 min.	60 min.
Boorkop		1,5 - 10 mm	1,5 - 10 mm	0,8 - 10 mm	0,8 - 10 mm
Aantal accu's		2 x BL1020B	2 x BL1040B	2 x BL1020B	2 x BL1040B
Gewicht		1,2 kg	1,2 kg	1,2 kg	1,2 kg
Prijs in €	Excl. BTW				
	Incl. BTW				

UNIVERSELE ACCUSCHAAR

CP100DSY1J

NIEUW



		CP100DSY1J
Batterijcapaciteit		10,8 V / 1,5 Ah
Gemiddelde oplaadtijd		30 min.
Snijcapaciteit		6 mm
Aantal accu's		1 x BL1015
Gewicht		0,72 kg
Prijs in €	Excl. BTW	
	Incl. BTW	

ACCU STOFZUIGER

CL107FDZW

NIEUW



		CL107FDZW
Batterijcapaciteit		10,8 V
Gebruiksduur op		hoge snelheid: 20 min. lage snelheid: 50 min.
Max. debiet		1,4 m³/min
Aantal accu's		0
Gewicht		1,1 kg
Prijs in €	Excl. BTW	
	Incl. BTW	

ACCU VENTILATOR

CF100DZ

NIEUW



		CF100DZ
Batterijcapaciteit		10,8 V
Luchtsnelheid		hoog: 3,0 m/sec laag: 2,0 m/sec
Aantal accu's		0
Gewicht		BL1040B: 1,4 kg
Prijs in €	Excl. BTW	
	Incl. BTW	

ACCU BOORHAMER SDS+ LXT 18V
DHR171ZJ / DHR171RTJ

NIEUW

18V
LITHIUM-ION

BL
MOTOR



	DHR171ZJ	DHR171RTJ
Batterijcapaciteit	18 V	18 V / 5,0 Ah
Gemiddelde oplaadtijd	-	45 min.
Slagenergie	1,2 J	1,2 J
Optimale Ø beton	4 - 8 mm	4 - 8 mm
Aantal accu's	0	2 x BL1850B
Gewicht	2,8 kg	2,8 kg
Prijs in €	Excl. BTW	
	Incl. BTW	

Batterijcapaciteit	18 V	18 V / 5,0 Ah
Gemiddelde oplaadtijd	-	45 min.
Slagenergie	1,2 J	1,2 J
Optimale Ø beton	4 - 8 mm	4 - 8 mm
Aantal accu's	0	2 x BL1850B
Gewicht	2,8 kg	2,8 kg
Prijs in €	Excl. BTW	
	Incl. BTW	

DIAMANTZAAG

4100KB

NIEUW

leverbaar
vanaf november



4100KB

Vermogen	1400 W
Zaagdiepte (0°)	40 mm
Ø Zaagblad	125 mm
Gewicht	3,0 kg
Prijs in €	Excl. BTW
	Incl. BTW

ACCU AFKORTZAAG 165 MM LXT 18V

DLS600Z / DLS600RTE

NIEUW

BL
MOTOR

18V
LITHIUM-ION



	DLS600Z	DLS600RTE
Batterijcapaciteit	18 V	18 V / 5,0 Ah
Gemiddelde oplaadtijd	-	45 min.
Ø Zaagblad	165 mm	165 mm
Maximale zaagcapaciteit bij 90°	46 x 92 mm	46 x 92 mm
Aantal accu's	0	2 x BL1850B
Gewicht	6,6 kg	6,6 kg
Prijs in €	Excl. BTW	
	Incl. BTW	

Batterijcapaciteit	18 V	18 V / 5,0 Ah
Gemiddelde oplaadtijd	-	45 min.
Ø Zaagblad	165 mm	165 mm
Maximale zaagcapaciteit bij 90°	46 x 92 mm	46 x 92 mm
Aantal accu's	0	2 x BL1850B
Gewicht	6,6 kg	6,6 kg
Prijs in €	Excl. BTW	
	Incl. BTW	

BREEKHAMER VOOR SDS-MAX
HM0870C / HM0870CV

PROMO



HM0870C

CV modellen
inclusief stofzuigset



Stofzuiger VC3011L bij
model CV ter waarde
van € 219,00



Beitelset met 5 beitels
SDS-Max bij C model
ter waarde van € 82,00

		HM0870C	HM0870CV
Prijs in €	Excl. BTW		
	Incl. BTW		

BREEKHAMER VOOR SDS-MAX
HM0871C / HM0871CV

PROMO

AVT
ANTI VIBRATION TECHNOLOGY



HM0871C

CV modellen
inclusief stofzuigset



Stofzuiger VC3011L bij
model CV ter waarde
van € 219,00



Beitelset met 5 beitels
SDS-Max bij C model
ter waarde van € 82,00

		HM0871C	HM08701CV
Prijs in €	Excl. BTW		
	Incl. BTW		

BREEKHAMER VOOR SDS-MAX
HM1101C / HM1101CV

PROMO



HM1101C

CV modellen
inclusief stofzuigset



Stofzuiger VC3011L bij
model CV ter waarde
van € 219,00



Beitelset met 5 beitels
SDS-Max bij C model
ter waarde van € 82,00

		HM1101C	HM1101CV
Prijs in €	Excl. BTW		
	Incl. BTW		

BREEKHAMER VOOR SDS-MAX
HM1111C / HM1111CV

PROMO

AVT
ANTI VIBRATION TECHNOLOGY



HM1111C

CV modellen
inclusief stofzuigset



Stofzuiger VC3011L bij
model CV ter waarde
van € 219,00



Beitelset met 5 beitels
SDS-Max bij C model
ter waarde van € 82,00

		HM1111C	HM1111CV
Prijs in €	Excl. BTW		
	Incl. BTW		

BREEKHAMER VOOR SDS-MAX
HM1203C / HM1203CV

PROMO



Stofzuiger VC3011L bij
model CV ter waarde
van € 219,00

Beitelset met 5 beitels
SDS-Max bij C model
ter waarde van € 82,00

		HM1203C	HM1203CV
Prijs in €	Excl. BTW		
	Incl. BTW		

BREEKHAMER VOOR SDS-MAX
HM1213C / HM1213CV

PROMO

AVT
ANTI VIBRATION TECHNOLOGY



Stofzuiger VC3011L bij
model CV ter waarde
van € 219,00

Beitelset met 5 beitels
SDS-Max bij C model
ter waarde van € 82,00

		HM1213C	HM1213CV
Prijs in €	Excl. BTW		
	Incl. BTW		

BREEKHAMER VOOR SDS-MAX
HM1214C / HM1214CV

PROMO

AVT
ANTI VIBRATION TECHNOLOGY



Stofzuiger VC3011L bij
model CV ter waarde
van € 219,00

Beitelset met 5 beitels
SDS-Max bij C model
ter waarde van € 82,00

		HM1214C	HM1214CV
Prijs in €	Excl. BTW		
	Incl. BTW		

BOOR- EN BREEKHAMER VOOR SDS-MAX
HR4013C / HR4013CV

PROMO

AVT
ANTI VIBRATION TECHNOLOGY



Stofzuiger VC3011L bij
model CV ter waarde
van € 219,00

Boor- en breekhamer
HR2470FTP bij C model
ter waarde van € 199,00

		HR4013C	HR4013CV
Prijs in €	Excl. BTW		
	Incl. BTW		

BOOR- EN BREEKHAMER VOOR SDS-MAX
HR4511C / HR4511CV

PROMO

AVT
ANTI VIBRATION TECHNOLOGY



CV modellen
inclusief stofzuigset



Stofzuiger VC3011L bij
model CV ter waarde
van € 219,00

Boor- en breekhamer
HR2470FTP bij C model
ter waarde van € 199,00



		HR4511C	HR4511CV
Prijs in €	Excl. BTW		
	Incl. BTW		

BOOR- EN BREEKHAMER VOOR SDS-MAX
HR5212C / HR5212CV

PROMO

AVT
ANTI VIBRATION TECHNOLOGY



CV modellen
inclusief stofzuigset



Stofzuiger VC3011L bij
model CV ter waarde
van € 219,00

Boor- en breekhamer
HR2470FTP bij C model
ter waarde van € 199,00



		HR5212C	HR5212CV
Prijs in €	Excl. BTW		
	Incl. BTW		



BOOR- EN BEITELHAMERS SDS-PLUS
HR2470FTP / HR2630TX12 / HR2631FT12

PROMO



12 boren, 2 puntbeitels en
3 platte beitels in alu koffer
ter waarde van € 38,00

		HR2470FTP	HR2630TX12	HR2631FT12
Prijs in €	Excl. BTW			
	Incl. BTW			

SLOOPHAMER AVT MET ZESKANTOPNAME
HM1812

PROMO

AVT
ANTI VIBRATION TECHNOLOGY



Transportwagen
ter waarde
van € 72,00

HM1812

Prijs in €	Excl. BTW	
	Incl. BTW	



ACCU BOORHAMER LXT SDS-PLUS
DHR243RTJ

PROMO



BL
MOTOR

18V
LITHIUM-ION

Led accu werklamp
ter waarde van € 49,00



DHR243RTJ

Prijs in €	Excl. BTW	
	Incl. BTW	

ACCU BOORHAMER LXT SDS-PLUS MET
STOF AFZUIGING DHR243RTJV

PROMO



18V
LITHIUM-ION

BL
MOTOR

Led accu werklamp
ter waarde van € 49,00



DHR243RTJV

Prijs in €	Excl. BTW	
	Incl. BTW	

1400W HAAKSE SLIJPER 125 MM 9565PCV01 **PROMO**



+ 10 x doorslijp-schijven
125MMx1.2MM



		9565PCV01
Prijs in €	Excl. BTW	
	Incl. BTW	

POWERPACK + ACCU HAAKSE SLIJPER 125 MM **198835-2**



		198835-2
Prijs in €	Excl. BTW	
	Incl. BTW	

BL1850B

ACCU HAAKSE SLIJPER LXT 125 MM DGA506RTJ **PROMO**



Bluetooth speaker
DMR200 ter
waarde van € 99,00



		DGA506RTJ
Prijs in €	Excl. BTW	
	Incl. BTW	



ACCU HAAKSE SLIJPER LXT 125 MM
DGA506ZJX1

PROMO



+ 5 x doorslijpschijven
inox 0.8x125mm
+ accu 3Ah BL1830 na
online registratie



DGA506ZJX1

Prijs in €	Excl. BTW	
	Incl. BTW	

ACCU HAAKSE SLIJPER LXT 125 MM
DGA508RTJ1

PROMO



Bluetooth speaker
DMR200 ter
waarde van € 99,00



DGA508RTJ

Prijs in €	Excl. BTW	
	Incl. BTW	

1450W HAAKSE SLIJPERS 125 MM
GA5021C / CY

PROMO



GA5021CY met
Dodemansschakelaar

+ 10 x doorslijp-
schijven
125MMx1.2MM



GA5021C GA5021CY

Prijs in €	Excl. BTW		
	Incl. BTW		

1400W HAAKSE SLIJPER 125 MM
GA5040CJD

PROMO



+ veiligheidsbril



GA5040CJD

Prijs in €	Excl. BTW	
	Incl. BTW	

2400W HAAKSE SLIJPER 230 MM
GA9030SF01 / GA9030RF01

PROMO



Model RF met elektronische startbeveiliging



		GA9030SF01	GA9030RF01
Prijs in €	Excl. BTW		
	Incl. BTW		

2600W HAAKSE SLIJPER 230 MM
GA9040SF01 / GA9040RF01

PROMO



Model RF met elektronische startbeveiliging



		GA9040SF01	GA9040RF01
Prijs in €	Excl. BTW		
	Incl. BTW		

SLEUVENSLIJPER 150 MM

SG150

PROMO



		SG150
Prijs in €	Excl. BTW	
	Incl. BTW	

SLEUVENSLIJPER 180 MM

SG180

PROMO



		SG180
Prijs in €	Excl. BTW	
	Incl. BTW	

INVALZAAG 165 MM

SP6000J1

PROMO



2 x rail 1,4m +
1 x koppelstrip

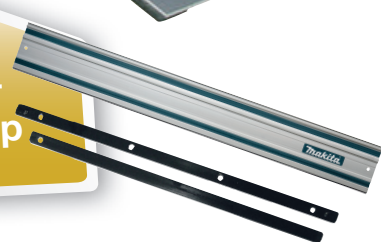

SP6000J1

Prijs in €	Excl. BTW	
	Incl. BTW	

1500W RECIPROZAAG

JR3070CT

PROMO

AVT
ANTI VIBRATION TECHNOLOGY



Bluetooth speaker
DMR200 ter
waarde van € 99,00



JR3070CT

Prijs in €	Excl. BTW	
	Incl. BTW	

TAFEL-, AFKORT- EN VERSTEKZAAG LH1040F

PROMO



Bluetooth speaker
DMR200 ter
waarde van € 99,00



LH1040F

Prijs in €	Excl. BTW	
	Incl. BTW	

TAFEL-, AFKORT- EN VERSTEKZAAG LH1201FL

PROMO



Bluetooth speaker
DMR200 ter
waarde van € 99,00



LH1201FL

Prijs in €	Excl. BTW	
	Incl. BTW	

TELESCOPISCHE VERSTEKZAAG LS0714FLB **PROMO**



DEAWST06
Onderstel ter
waarde van € 189,00

		LS0714FLB
Prijs in €	Excl. BTW	
	Incl. BTW	



TELESCOPISCHE VERSTEKZAAG LS1019L **PROMO**



NIEUW

DEAWST06
Onderstel ter
waarde van € 189,00

		LS1019L
Prijs in €	Excl. BTW	
	Incl. BTW	

TELESCOPISCHE VERSTEKZAAG LS1216FLB **PROMO**



DEAWST06
Onderstel ter
waarde van € 189,00

		LS1216FLB
Prijs in €	Excl. BTW	
	Incl. BTW	

ACCU BOOR- EN SCHROEFMACHINE LXT DDF483RTJ

PROMO



18V LITHIUM-ION



69-delige boor- en schroefset in MAKPAC koffer ter waarde van € 66,50



DDF483RTJ

Prijs in €	Excl. BTW	
	Incl. BTW	

ACCU KLOPBOOR- EN SCHROEFMACHINE LXT DHP484RTJ

PROMO



18V LITHIUM-ION



69-delige boor- en schroefset in MAKPAC koffer ter waarde van € 66,50



DHP484RTJ

Prijs in €	Excl. BTW	
	Incl. BTW	

ACCU EXCENTERSCHUURMACHINE 125MM LXT DBO180RTJ

PROMO



18V LITHIUM-ION

Led accu werklamp ter waarde van € 49,00



DBO180RTJ

Prijs in €	Excl. BTW	
	Incl. BTW	

ACCU SCHROEFAUTOMAAT LXT DFR550RTJ

PROMO



18V LITHIUM-ION

Led accu werklamp ter waarde van € 49,00



DFR550RTJ

Prijs in €	Excl. BTW	
	Incl. BTW	

ACCU HANDCIRKELZAAG LXT DHS680RTJ **PROMO**



Led accu werklamp
ter waarde van € 49,00



		DHS680RTJ
Prijs in €	Excl. BTW	
	Incl. BTW	

ACCU RECIPROZAAG LXT DJR187RTE **PROMO**



Led accu werklamp
ter waarde van € 49,00



		DJR187RTE
Prijs in €	Excl. BTW	
	Incl. BTW	

ACCU SLAGSCHROEVENDRAAIER LXT

DTD155RTJ **PROMO**



Led accu werklamp
ter waarde van € 49,00



		DTD155RTJ
Prijs in €	Excl. BTW	
	Incl. BTW	

SLAGMOERSLEUTEL LXT DTW1001RTJ **PROMO**



Dopaansluiting vierkant 3/4"

18V
LITHIUM-ION



Led accu werklamp ter waarde van € 49,00

DTW1001RTJ

Prijs in €	Excl. BTW	
	Incl. BTW	

SLAGMOERSLEUTEL LXT DTW1002RTJ **PROMO**



Dopaansluiting vierkant 1/2"

18V
LITHIUM-ION



Led accu werklamp ter waarde van € 49,00

DTW1002RTJ

Prijs in €	Excl. BTW	
	Incl. BTW	

SLAGMOERSLEUTEL LXT DTW285RTJ **PROMO**



18V
LITHIUM-ION



Led accu werklamp ter waarde van € 49,00

DTW285RTJ

Prijs in €	Excl. BTW	
	Incl. BTW	

SLAGMOERSLEUTEL LXT DTW450RTJ **PROMO**



18V
LITHIUM-ION



Led accu werklamp ter waarde van € 49,00

DTW450RTJ

Prijs in €	Excl. BTW	
	Incl. BTW	

KRUISLIJN- EN PUNTLASER

SK103PZ

PROMO



Statief 1,5m ter waarde van € 43,00



		SK103PZ
Prijs in €	Excl. BTW	
	Incl. BTW	

KRUISLIJNLASER

SK104Z

PROMO



Statief 1,5m ter waarde van € 43,00



		SK104Z
Prijs in €	Excl. BTW	
	Incl. BTW	

LIJNLASERS

SK209GDZ / SK312GDZ

PROMO



NIEUW



SK209GDZ

SK312GDZ

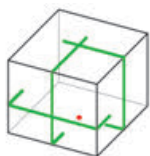

SK209GDZ

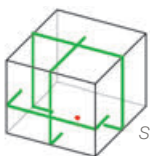

SK312GDZ

+ Powerpack 197657-7



		SK209GDZ	SK312GDZ
Prijs in €	Excl. BTW		
	Incl. BTW		

ROTTERENDE LASER

SKR200Z

PROMO



Statief ter waarde van € 143,00



		SKR200Z
Prijs in €	Excl. BTW	
	Incl. BTW	

ACCU BLADBLAZER LXT

DUB362Z

PROMO

18v + 18v → 36v



+ Platte blaasmond

DUB362Z

Prijs in €	Excl. BTW	
	Incl. BTW	

ACCU KRUIWAGEN LXT 18V

DCU180Z

PROMO

leverbaar vanaf december

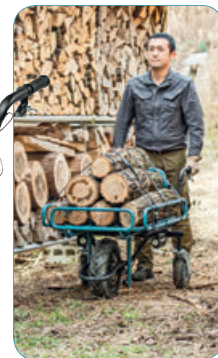

Optioneel accessoire :
Buizenframe (199009-8)

+ kuip



Uitgerust met LED verlichting (2x)

DCU180Z

Prijs in €	Excl. BTW	
	Incl. BTW	

ELEKTRISCHE KETTINGZAGEN

UC3051A / UC3551AK / UC4051AK / UC4551A

PROMO



+ handbijl

UC3051A

UC3551AK

Prijs in €	Excl. BTW		
	Incl. BTW		

UC4051AK

UC4551A

Prijs in €	Excl. BTW		
	Incl. BTW		

BENZINE KETTINGZAGEN

EA4300F38C / EA4300F45C-KIT

PROMO



EA4300F45C-KIT



EA4300F38C

+ handbijl

EA4300F38C

EA4300F45C-KIT

Prijs in €	Excl. BTW		
	Incl. BTW		

HIGH PRESSURE COMPRESSOR AC310H **PROMO**



Trolley / Transport-
wagen ter waarde
van € 143,00



		AC310H
Prijs in €	Excl. BTW	
	Incl. BTW	

BOVENFREES 2300W RP2300FCX1J **PROMO**



Bluetooth speaker
DMR200 ter
waarde van € 99,00



		RP2300FCX1J
Prijs in €	Excl. BTW	
	Incl. BTW	

ACCU BOOR- EN SCHROEFMACHINE DF012DSJ

7.2V
LITHIUM-ION



NIEUW

		DF012DSJ
Prijs in €	Excl. BTW	
	Incl. BTW	

ACCU PENPACT SCHROEVENDRAAIER TD022DSJ

7.2V
LITHIUM-ION



		TD022DSJ
Prijs in €	Excl. BTW	
	Incl. BTW	



Makita

Makita

130kg



10.8V
LITHIUM-ION



BL1020B
2.0Ah



BL1040B
4.0Ah

VERVOLLEDIG UW GEREEDSCHAP DANKZIJ HET GROTE



Snellader DC10SA

Een 2.0 Ah schuifbatterij
volledig opgeladen in

30 minuten

CXT



DC10SA



BL1020B

Speciaal ontwikkeld voor het opladen van de nieuwe Li-ion 10.8V schuifbatterijen

ASSORTIMENT MACHINES ZONDER ACCU'S EN LADER.

DA333DZJ



ST113DZJ



CF100DZJ



PT354DZJ



CP100DZJ



TL065DZJ



SD100DZJ



10.8V LITHIUM-ION

JR103D



CC301D



TM30D



JV101D
JV102D
JV103D



TD110D
TD111D



DA332D
DA333D



TL064D
TL065D



HR140D
HR166D



CG100D



HS301D



**DF331D
DF332D**



**DF031D
DF032D**



**HP331D
HP332D**



CF100D



CL107D



PT354D



ST113D



CP100D



SD100D



RECHTE ACCU SCHROEFMACHINE 3,6V LI-ION



DF001DW	
Batterijcapaciteit	3,6 V / 1,5 Ah
Gemiddelde oplaadtijd	3 - 5 u.
Max. koppel (harde verbinding)	4 Nm
Gewicht	0,36 kg
Bitopname	1/4" hex.
Gewicht	0,5 kg
Prijs in €	Excl. BTW
	Incl. BTW



ACCU BOOR- EN SCHROEFMACHINES



		TD022DSJ	DF012DSJ
		NIEUW	
Batterijcapaciteit		7,2 V / 1,5 Ah	7,2 V / 1,5 Ah
Gemiddelde oplaadtijd		30 min.	30 min.
Toerental		0-2450 t.p.m.	0-650 t.p.m.
Hard koppel		25 Nm	5,6 Nm
Bitopname		1/4" hex.	1/4" hex.
Aantal accu's		2 x BL7015	2 x BL7015
Gewicht		0,5 kg	0,53 kg
Prijs in €	Excl. BTW		
	Incl. BTW		

DF012DSJ



ACCU BOOR- EN SCHROEFMACHINES 10,8V LI-ION



DF032



DF032DSMJ



DF031DSAJ



		DF031DSAJ	DF031DSMJ	DF032DSAJ	DF032DSMJ
Batterijcapaciteit		10,8 V / 2,0 Ah	10,8 V / 4,0 Ah	10,8 V / 2,0 Ah	10,8 V / 4,0 Ah
Gemiddelde oplaadtijd		30 min.	60 min.	30 min.	60 min.
Hard koppel		30 Nm	30 Nm	35 Nm	35 Nm
Aantal accu's		2	2	2	2
Gewicht		0,9 kg	0,9 kg	0,88 kg	0,88 kg
Prijs in €	Excl. BTW				
	Incl. BTW				

ACCU BOOR- EN SCHROEFMACHINES 10,8V LI-ION



DF332



DF331DSAX1



DF331DSMJ



DF332DSMJ



		DF331DSAJ	DF331DSMJ	DF332DSAJ	DF331DSAX1	DF332DSMJ
Batterijcapaciteit		10,8 V / 2,0 Ah	10,8 V / 4,0 Ah	10,8 V / 2,0 Ah	10,8 V / 2,0 Ah	10,8 V / 4,0 Ah
Gemiddelde oplaadtijd		30 min.	60 min.	30 min.	30 min.	60 min.
Hard koppel		30 Nm	30 Nm	35 Nm	30 Nm	35 Nm
Aantal accu's		2	2	2	2	2
Gewicht		1,1 kg	1,1 kg	1,2 kg	1,1 kg	1,2 kg
Prijs in €	Excl. BTW					
	Incl. BTW					

ACCU KLOPBOOR- EN SCHROEFMACHINES 10,8V LI-ION



HP332DSMJ



HP331DSMJ



		HP331DSAJ	HP331DSMJ	HP332DSAJ	HP332DSMJ
Batterijcapaciteit		10,8 V / 2,0 Ah	10,8 V / 4,0 Ah	10,8 V / 2,0 Ah	10,8 V / 4,0 Ah
Gemiddelde oplaadtijd		30 min.	60 min.	30 min.	60 min.
Hard koppel		30 Nm	30 Nm	35 Nm	35 Nm
Aantal accu's		2	2	2	2
Gewicht		1,1 kg	1,1 kg	1,1 kg	1,3 kg
Prijs in €	Excl. BTW				
	Incl. BTW				

SCHROEFBITSET

43-delige schroefbitset met kleurgecodeerde bits

B-55697



ACCU BOORHAMERS 10,8V LI-ION



Model HR166DWAE1 met 74-delige bitset.



HR166DSMJ



HR140DSMJ

		NIEUW HR140DSAJ	NIEUW HR140DSMJ	NIEUW HR166DSMJ	NIEUW HR166DWAE1
Batterijcapaciteit		10,8 V / 2,0 Ah	10,8 V / 4,0 Ah	10,8 V / 4,0 Ah	10,8 V / 2,0 Ah
Gemiddelde oplaadtijd		30 min.	60 min.	60 min.	30 min.
Slagenergie		1,0 J	1,0 J	1,1 J	1,1 J
Optimale Ø beton		4 - 8 mm	4 - 8 mm	4 - 10 mm	4 - 10 mm
Aantal accu's		2	2	2	2
Gewicht		1,9 kg	1,9 kg	1,8 kg	1,8 kg
Prijs in €	Excl. BTW				
	Incl. BTW				

ACCU HAAKSE BOORMACHINES 10,8V LI-ION



NIEUW **NIEUW** **NIEUW** **NIEUW**

	DA332DSAJ	DA332DSMJ	DA333DSAJ	DA333DSMJ
Batterijcapaciteit	10,8 V / 2,0 Ah	10,8 V / 4,0 Ah	10,8 V / 2,0 Ah	10,8 V / 4,0 Ah
Gemiddelde oplaadtijd	30 min.	60 min.	30 min.	60 min.
Boorkop	1,5 - 10 mm	0,8 - 10 mm	1,5 - 10 mm	0,8 - 10 mm
Aantal accu's	2 x BL1040B	2 x BL1040B	2 x BL1040B	2 x BL1040B
Gewicht	1,2 kg	1,2 kg	1,2 kg	1,2 kg
Prijs in €	Excl. BTW			
	Incl. BTW			

ACCU SLAGSCHROEVENDRAAIERS 10,8V LI-ION



	TD110DSAJ	TD111DSAJ	TD110DSMJ	TD111DSMJ
Batterijcapaciteit	10,8 V / 2,0 Ah	10,8 V / 2,0 Ah	10,8 V / 4,0 Ah	10,8 V / 4,0 Ah
Gemiddelde oplaadtijd	30 min.	30 min.	60 min.	60 min.
Hard koppel	110 Nm	135 Nm	110 Nm	135 Nm
Aantal accu's	2	2	2	2
Gewicht	1,0 kg	0,97 kg	1,0 kg	0,97 kg
Prijs in €	Excl. BTW			
	Incl. BTW			

TD111: Assist mode voor het vlot aanzetten bij het schroeven.

ACCU HAAKSE SLAGSCHROEVENDRAAIERS CXT 10,8V



	TL064DZJ	TL065DZJ
Batterijcapaciteit	10,8 V	10,8 V
Gemiddelde oplaadtijd	30 min. / 60 min.	30 min. / 60 min.
Toerental	0-2000 t.p.m.	0-2000 t.p.m.
Aantal accu's	0	0
Gewicht	1,2 kg	1,2 kg
Prijs in €	Excl. BTW	
	Incl. BTW	

ACCU TEGEL EN- GLASSNIJDER



CC301DSMJ



	CC301DZJ	CC301DSMJ
Batterijcapaciteit	10,8 V	10,8 V / 4,0 Ah
Gemiddelde oplaadtijd	30 min. / 60 min.	60 min.
Zaagdiepte (90°)	25,5 mm	25,5 mm
Ø Zaagblad	85 mm	85 mm
Aantal accu's	-	2 x BL1040B
Gewicht	1,9 kg	1,9 kg
Opvolger van	CC300DWE	
Prijs in €	Excl. BTW	
	Incl. BTW	

ACCU GIPSAAG10,8V LI-ION



NIEUW

SD100DZJ

	SD100DZJ	
Batterijcapaciteit	10,8 V	
Gemiddelde oplaadtijd	30 min. / 60min.	
Slaglengte	6 mm	
Aantal accu's	0	
Gewicht	1,5 kg	
Prijs in €	Excl. BTW	
	Incl. BTW	

ACCU HANDCIRKELZAAG 10,8V LI-ION



HS301DSMJ



	HS301DSAJ	HS301DSMJ
Batterijcapaciteit	10,8 V / 2,0 Ah	10,8 V / 4,0 Ah
Gemiddelde oplaadtijd	30 min.	60 min.
Maximale zaagdiepte bij 90°	25,5 mm	25,5 mm
Aantal accu's	2	2
Gewicht	1,6 kg	1,6 kg
Prijs in €	Excl. BTW	
	Incl. BTW	



ACCU WIPZAAG CXT 10,8V LI-ION



JV102DSAJ



JV103DSAJ



JV102
JV103



		NIEUW	NIEUW	NIEUW	NIEUW
	JV101DSAJ	JV102DSAJ	JV102DSMJ	JV103DSAJ	JV103DSMJ
Batterijcapaciteit	10,8 V / 2,0 Ah	10,8 V / 2,0 Ah	10,8 V / 4,0 Ah	10,8 V / 2,0 Ah	10,8 V / 4,0 Ah
Gemiddelde oplaadtijd	30 min.	30 min.	60 min.	30 min.	60 min.
Aantal zaagbewegingen	0-2900 /min.	800-3000 /min.	800-3000 /min.	800-3000 /min.	800-3000 /min.
Maximale capaciteit hout	65 mm	90 mm	90 mm	90 mm	90 mm
Aantal accu's	2 x BL1020B	2 x BL1020B	2 x BL1040B	2 x BL1020B	2 x BL1040B
Gewicht	1,7 kg	1,8 kg	1,8 kg	1,8 kg	1,8 kg
Prijs in €	Excl. BTW				
	Incl. BTW				

ACCU RECIPROZAAG 10,8V LI-ION



JR103DSMJ



	JR103DSAJ	JR103DSMJ
Batterijcapaciteit	10,8 V / 2,0 Ah	10,8 V / 4,0 Ah
Gemiddelde oplaadtijd	30 min.	60 min.
Max. zaagcapaciteit hout/stalen buis	50 mm	50 mm
Aantal accu's	2	2
Gewicht	1,3 kg	1,5 kg
Prijs in €	Excl. BTW	
	Incl. BTW	

MULTIFUNCTIONEEL OSCILLEREND GEREEDSCHAP CXT 10,8V



	TM30DSAJX3
Batterijcapaciteit	10,8 V / 2,0 Ah
Gemiddelde oplaadtijd	30 min.
Oscillatiehoek	3,2 °
Oscillatiefrequentie	6000-20000 min-1
Aantal accu's	2 x BL1020B
Gewicht	1,1 kg
Prijs in €	Excl. BTW
	Incl. BTW

UNIVERSELE ACCUSCHAAR CXT 10,8V



	CP100DSY1J
Batterijcapaciteit	10,8 V / 1,5 Ah
Gemiddelde oplaadtijd	30 min.
Snijcapaciteit	6 mm
Gewicht	0,72 kg
Prijs in €	Excl. BTW
	Incl. BTW

ACCU NIETMACHINE 10,8V LI-ION



ST113DSMJ

	ST113DZJ	ST113DSAJ	ST113DSMJ
Batterijcapaciteit	10,8 V	10,8 V / 2,0 Ah	10,8 V / 4,0 Ah
Gemiddelde oplaadtijd	30 min. / 60 min.	30 min.	60 min.
Rugbreedte niet	10 mm	10 mm	10 mm
Ladercapaciteit	150 stuks	150 stuks	150 stuks
Aantal accu's	0	2	2
Gewicht	1,3 kg	1,3 kg	1,5 kg
Prijs in €	Excl. BTW		
	Incl. BTW		

ACCU AFWERKINGSPISTOOL 10,8V LI-ION



PT354DSMJ



	NIEUW PT354DZJ	NIEUW PT354DSAJ	NIEUW PT354DSMJ
Batterijcapaciteit	10,8 V	10,8 V / 2,0 Ah	10,8 V / 4,0 Ah
Gemiddelde oplaadtijd	30 min. / 60 min.	30 min.	60 min.
Draadkallber	23 Ga	23 Ga	23 Ga
Doorsnede nagel	0,6 mm	0,6 mm	0,6 mm
Lengte nagel	15-35 mm	15-35 mm	15-35 mm
Aantal accu's	0	2	2
Gewicht	2,0 kg	2,0 kg	2,0 kg
Prijs in €	Excl. BTW		
	Incl. BTW		

ACCU KITPISTOOL 10,8V LI-ION



CG100DSAEB

CG100DZAK

	NIEUW CG100DZAK	NIEUW CG100DSAE	NIEUW CG100DSAEB
Batterijcapaciteit	10,8 V	10,8 V / 2,0 Ah	10,8 V / 2,0 Ah
Gemiddelde oplaadtijd	30 min. / 60 min.	30 min.	30 min.
Maximale extrusiekracht	5000 N	5000 N	5000 N
Maximale extrusiesnelheid	0-28 mm/s	0-28 mm/s	0-28 mm/s
Aantal accu's	0	2	2
Prijs in €	Excl. BTW		
	Incl. BTW		

ACCU STOFZUIGER 10,8V LI-ION



NIEUW



CL107FDZW

Batterijcapaciteit	10,8 V
Gebruiksduur op hoge / lage snelheid	20 min. / 50 min.
Max. debiet	1,4 m³/min
Gewicht	1,1 kg
Prijs in €	Excl. BTW
	Incl. BTW

ACCU VENTILATOR 10,8V LI-ION



NIEUW



CF100DZ

Batterijcapaciteit	10,8 V
Luchtsnelheid hoog / laag	3,0 m/sec / 2,0 m/sec
Gewicht BL1020B / BL1040B	1,2 kg / 1,4 kg
Prijs in €	Excl. BTW
	Incl. BTW

COMBOPACK 10,8V



Led zaklamp ter waarde van € 33,00

CLX202SAX2

Batterijcapaciteit	10,8 V / 2,0 Ah
Gemiddelde oplaadtijd	30 min.
Aantal accu's	3 x BL1020B
Slagschroevendraaier	TD110D
klopboormachine	HP331D
Batterijlader	DC10SA
Opvolger van	LCT303X1
Prijs in €	Excl. BTW
	Incl. BTW

COMBOPACK 10,8V



Werfradio ter waarde van € 49,00

CLX400SAJ1

Batterijcapaciteit	10,8 V / 2,0 Ah
Gemiddelde oplaadtijd	30 min.
Aantal accu's	3 x BL1020B
Slagschroevendraaier	TD110D
Boorschroefmachine	DF331D
Cirkelzaag	HS301D
Reciprozaag	JR103D
Batterijlader	DC10SA
Opvolger van	DK1474X1
Prijs in €	Excl. BTW
	Incl. BTW

COMBOPACK 10,8V



Led zaklamp ter waarde van € 33,00

CLX206SAX3

Batterijcapaciteit	10,8 V / 2,0 Ah
Gemiddelde oplaadtijd	30 min.
Aantal accu's	2 x BL1020B
Boorschroefmachine	DF331D
OIS multi tool	TM30D
Batterijlader	DC10SA
Prijs in €	Excl. BTW
	Incl. BTW

VERWARMDE JAS 10,8V LI-ION



10.8V

		CJ100DZ
Maat		S, M, L, XL, 2XL, 3XL
Batterijchemie		Li-ion
Nominale accu spanning		10,8 V
Geschatte constante werkingsduur		5 uur
Prijs in €	Excl. BTW	
	Incl. BTW	



VERWARMDE JAS 10,8V LI-ION



CXT

10.8V

		CJ102DZ
Maat		S, M, L, XL, 2XL, 3XL
Batterijchemie		Li-ion
Nominale accu spanning		10,8 V
Geschatte constante werkingsduur		4 - 14 uur
Prijs in €	Excl. BTW	
	Incl. BTW	

VERWARMDE JAS 14,4V - 18V LI-ION



14.4V LITHIUM-ION

18V LITHIUM-ION

		DC-J200DZ
Maat		S, M, L, XL, 2XL, 3XL
Batterijchemie		Li-ion
Nominale accu spanning		14,4 V - 18 V
Geschatte constante werkingsduur		17,5 uur 18V - 3,0 Ah
Prijs in €	Excl. BTW	
	Incl. BTW	



HET **LXT** PLATFORM

VERVOLLEDIG UW LI-ION GEREEDSCHAP DANKZIJ HET GROTE ASSORTIMENT MACHINES ZONDER ACCU'S EN LADER.



14.4V
18V
DMR050
€ EXCL. BTW
€ INCL. BTW



14.4V
BUB142Z
€ EXCL. BTW
€ INCL. BTW



MAK PAC **14.4V**
DTW280ZJ
€ EXCL. BTW
€ INCL. BTW



MAK PAC **14.4V**
DST111ZJ
€ EXCL. BTW
€ INCL. BTW



MAK PAC **18V**
DDF484ZJ
€ EXCL. BTW
€ INCL. BTW



MAK PAC **18V**
DHP481ZJ
€ EXCL. BTW
€ INCL. BTW



MAK PAC **18V**
DTD170ZJ
€ EXCL. BTW
€ INCL. BTW



18V
DFR750ZK
€ EXCL. BTW
€ INCL. BTW



MAK PAC **18V**
DJR183ZJ
€ EXCL. BTW
€ INCL. BTW



18V
DUB182Z
€ EXCL. BTW
€ INCL. BTW



18V
DCF300Z
€ EXCL. BTW
€ INCL. BTW



MAK PAC **18V**
DBO180ZJ
€ EXCL. BTW
€ INCL. BTW



18V
DSC191Z
€ EXCL. BTW
€ INCL. BTW



18V
DSC162Z
€ EXCL. BTW
€ INCL. BTW



18V
DST112ZJ
€ EXCL. BTW
€ INCL. BTW



MAK PAC **36V**
DHR264ZJ
€ EXCL. BTW
€ INCL. BTW



MAK PAC **36V**
BHR262TZJ
€ EXCL. BTW
€ INCL. BTW



MAK PAC **36V**
DHS710ZJ
€ EXCL. BTW
€ INCL. BTW



36V
DLS714Z
€ EXCL. BTW
€ INCL. BTW



36V
DJR360ZK
€ EXCL. BTW
€ INCL. BTW



DCM500Z
€ EXCL. BTW
€ INCL. BTW

BATTERIJ BL1020B 10,8V
197394-3



€ EXCL. BTW
€ INCL. BTW

BATTERIJ BL1040B 10,8V
197402-0



€ EXCL. BTW
€ INCL. BTW

POWER PACK 10,8V 2.0AH
197657-7



€ EXCL. BTW
€ INCL. BTW

POWER PACK 10,8V 4.0AH
197636-5



€ EXCL. BTW
€ INCL. BTW

POWER PACK 2 X 18V 4.0AH
197494-9



€ EXCL. BTW
€ INCL. BTW

POWER PACK 2 X 18V 4.0AH
197504-2



€ EXCL. BTW
€ INCL. BTW

POWER PACK 2 X 18V 5.0AH
197629-2



€ EXCL. BTW
€ INCL. BTW

POWER PACK 4 X 18V 5.0AH
197626-8



€ EXCL. BTW
€ INCL. BTW

TWIN PACK 2 X 18V 4.0AH
197273-5



€ EXCL. BTW
€ INCL. BTW

TWIN PACK 2 X 18V 5.0AH
197288-2



€ EXCL. BTW
€ INCL. BTW

BATTERIJ BL1840B 4.0AH
197265-4



€ EXCL. BTW
€ INCL. BTW

BATTERIJ BL1850B 5.0AH
197280-8



€ EXCL. BTW
€ INCL. BTW

BATTERIJ BL1860B 6.0AH
197422-4



€ EXCL. BTW
€ INCL. BTW

OPLADER DC10SA
197355-3

Snellader voor Li-Ion schuifaccu's van 10,8V.



€ EXCL. BTW
€ INCL. BTW

OPLADER DC18RC
195584-2

Snellader voor Li-Ion en Ni-MH schuifaccu's van 9,6 t/m 18V.



€ EXCL. BTW
€ INCL. BTW

DUBBELLADER DC18RD
196933-6

Duo snellader voor Li-Ion en Ni-MH schuifaccu's van 9,6 t/m 18V.



2 batterijen BL1830 laden in 22 minuten

€ EXCL. BTW
€ INCL. BTW

NIUW OPLADER DC18RE
198720-9

Snellader, geschikt voor zowel CXT als LXT Li-Ion accu's.



€ EXCL. BTW
€ INCL. BTW

OPLAADTIJDEN BATTERIJEN		
	18V Lithium-ion	14,4V Lithium-ion
6,0 AH	BL1860B ⇓⇓⇓ DC18RC DC18RD	BL1460B ⇓⇓⇓ DC18RC DC18RD
	55 min.	
5,0 AH	BL1850B ⇓⇓⇓ DC18RC DC18RD	-
	45 min.	
4,0 AH	BL1840B ⇓⇓⇓ DC18RC DC18RD	BL1440 ⇓⇓⇓ DC18RC DC18RD
	36 min.	
3,0 AH	BL1830 ⇓⇓⇓ DC18RC DC18RD	BL1430 ⇓⇓⇓ DC18RC DC18RD
	22 min.	
2,0 AH	BL1820B ⇓⇓⇓ DC18RC DC18RD	-
	24min.	
10,8V Lithium-ion		
4,0 AH	BL1040B ⇓⇓⇓ DC10SA	-
	60 min.	
2,0 AH	BL1020B ⇓⇓⇓ DC10SA	-
	30 min.	

PROMO
 Na online registratie
 + batterij BL1830
 ter waarde van € 125,00



MAK PAC DTL061ZJ



DSS501ZJ



MAK PAC DCS551ZJ



MAK PAC DHS630ZJ



MAK PAC DGA506ZJ



MAK PAC DST221ZJ

DGA508ZJ



MAK PAC DTW1001ZJ

DTW1002ZJ



MAK PAC DTM51ZJX2



MAK PAC DGD800ZJ



MAK PAC DPJ180ZJ



MAK PAC DTW450ZJ

DTW450ZJ



MAK PAC DPT351ZJ

DPT351ZJ



DJR186ZK

DJR187ZK



MAK PAC DBN500ZJ

DBN500ZJ



DCG180ZK



incl. kokerhouder (196352-6)
 DCG180ZXK



MAK PAC DJN161ZJ

DJN161ZJ



MAK PAC DJS130ZJ

DJS130ZJ

DVR350ZK
 DVR450ZK
 DVR850ZK



KOOP NU EN ONTVANG EEN GRATIS BATTERIJ

Makita belooft zijn klanten: van 1 oktober 2017 tot en met 31 maart 2018 ontvang je een gratis 18V 3,0Ah batterij (BL1830) als je in die periode één van bovenstaande 18V machines aanschaft. De actie geldt enkel voor bepaalde basis uitvoeringen zonder batterijen en snellader.



De actie is uitsluitend bedoeld voor de Belgische en Luxemburgse markt en enkel voor eindgebruikers die in België of Luxemburg wonen. De machine dient te zijn aangeschaft bij een officiële en geautoriseerde dealer van Makita België NV. Deze dealers kun je vinden in de dealerlocator op www.makita.be. Daar kan je ook de complete voorwaarden van deze actie raadplegen. Actie niet cumuleerbaar met andere acties en promoties en niet van toepassing op machines die deel uitmaken van een combokit of een omruiling in het kader van een reparatie.



DKP180ZJ



DTW285ZJ



DTW190ZJ



DFR550ZJ



DCO180ZJ



DFS250ZJ



DJV181ZJ



DFS452ZJ



DJV182ZJ



DTP141ZJ



DTD153ZJ



DSD180ZJ

DTD154ZJ



DTD170ZJ



DHS680ZJ



DDA351ZJ



DPB181Z



DVC350Z



DDA350ZJ



DHR243ZJ



DHR202ZJ



DHR171ZJ



DHR243ZJ



PAK JE VOORDEEL

Koop een basis 18V machine bij je Makita dealer. Na je aankoop maak je op www.makita.be een account aan (of gebruik je een bestaande account) en vul je op het formulier onder andere het serienummer (staat op de machine) en de EANcode (barcode) in. Upload daarnaast ook een kopie van je aankoopfactuur. Na ontvangst van de correcte gegevens, sturen we de gratis batterij dan zo snel mogelijk en binnen 30 dagen naar je toe.

ACCU (KLOP) BOOR- EN SCHROEFMACHINES



14.4V 18V

DHP MET KLOPBOORFUNCTIE



XPT
EXTREME PROTECTION TECHNOLOGY



DHP481RT3J

BL MOTOR



BL MOTOR



XPT
EXTREME PROTECTION TECHNOLOGY

DDF481RT3J



DDF453RF3J

PROMO
3de ACCU 
ter waarde van € 140,00 (18V)
ter waarde van € 125,00 (14,4V)



BL MOTOR

XPT
EXTREME PROTECTION TECHNOLOGY



DDF470RM3J



DDF484RT3J

BL MOTOR



DDF482RM3J

XPT
EXTREME PROTECTION TECHNOLOGY



XPT
EXTREME PROTECTION TECHNOLOGY



DHP448RM3J



	DDF453RF3J	DDF482RM3J	DDF470RM3J	DDF484RT3J	DHP448RM3J	DDF481RT3J	DHP481RT3J
Batterijcapaciteit	18 V / 3,0 Ah	18 V / 4,0 Ah	14,4 V / 4,0 Ah	18 V / 5,0 Ah	14,4 V / 4,0 Ah	18 V / 5,0 Ah	18 V / 5,0 Ah
Gemiddelde oplaadtijd	22 min.	36 min.	36 min.	45 min.	36 min.	45 min.	45 min.
Hard koppel	42 Nm	62 Nm	46 Nm	54 Nm	77 Nm	115 Nm	115 Nm
Boorkop	1,5 - 13 mm	1,5 - 13 mm	1,5 - 13 mm	1,5 - 13 mm	1,5 - 13 mm	1,5 - 13 mm	1,5 - 13 mm
Aantal accu's	3 x BL1830	3 x BL1840	3 x BL1440	3 x BL1850	3 x BL1440	3 x BL1850	3 x BL1850
Gewicht	1,7 kg	1,7 kg	1,6 kg	1,5 kg	2,4 kg	2,4 kg	2,4 kg
Prijs in €	Excl. BTW						
	Incl. BTW						

ACCU (KLOP) BOOR- EN SCHROEFMACHINES



DHP MET KLOPBOORFUNCTIE



BL MOTOR
XPT
EXTREME PROTECTION TECHNOLOGY
DDF483RTJ

69-delige boor- en schroefset in MAK PAC koffer. ter waarde van € 66,50 bij DDF483RTJ & DHP484RTJ



BL MOTOR
XPT
EXTREME PROTECTION TECHNOLOGY

DHP484RTJ

	DDF343RYJ	DHP453RFJ	DHP470RMJ	DDF083RTJ	DDF483RTJ	DHP484RTJ
Batterijcapaciteit	14,4 V / 1,5 Ah	18 V / 3,0 Ah	14,4 V / 4,0 Ah	18 V / 5,0 Ah	18 V / 5,0 Ah	18 V / 5,0 Ah
Gemiddelde oplaadtijd	15 min.	22 min.	36 min.	45 min.	45 min.	45 min.
Hard koppel	36 Nm	42 Nm	46 Nm	40 Nm	40 Nm	54 Nm
Boorkop	1 - 10 mm	1,5 - 13 mm	1,5 - 13 mm	1,5-13 mm	1,5-13 mm	1,5-13 mm
Aantal accu's	2 x BL1415N	2 x BL1830	2 x BL1440	2 x BL1850B	2 x BL1850	2 x BL1850
Gewicht	1,4 kg	1,8 kg	1,7 kg	1,3 kg	1,5 kg	1,9 kg
Prijs in €	Excl. BTW					
	Incl. BTW					

MINI DIAMANTBOREN - Perfect geschikt voor het boren in (keramische) tegels, graniet, glas.

	Best. Nr.	Diameter (mm)	Lengte (mm)	Prijs	
				Excl. BTW	Incl. BTW
	P-66569	5	30		
	P-66575	6	30		
	P-66597	8	30		
	P-66612	10	30		
	P-66709	12	30		
	P-66721	20	30		
	P-66628	6/8/10	30		

BL MOTOR



DDF083RTJ

XPT
EXTREME PROTECTION TECHNOLOGY

Stof- en waterbestendig

Diverse constructiedetails zoals een volledig waterdichte schakelaar, een interne dichting die de batterij afschermt en in hars gegoten elektronische circuits staan garant voor de beste stof- en waterbestendigheid op de markt.



BL MOTOR

+ 50 % werkingsduur

Onderhoudsvrije koolborstelloze motor met elektronische sturing levert meer koppel, behoudt de volle kracht bij linksom draaien en verzet meer werk met dezelfde accucapaciteit.



COMBI-SET MET ACCU BOOR- EN SCHROEFMACHINE



DDF343RYX2

Batterijcapaciteit	14,4 V / 1,5 Ah	
Gemiddelde oplaadtijd	15 min.	
Hard koppel	36 Nm	
Boorkop	1 - 10 mm	
Aantal accu's	2 x BL1415N	
Gewicht	1,4 kg	
Prijs in €	Excl. BTW	
	Incl. BTW	

INCLUSIEF 59 ACCESSOIRES



COMBI-SET MET ACCU BOOR- EN SCHROEFMACHINE

18V

DHP453RFX2

Batterijcapaciteit	18 V / 3 Ah	
Gemiddelde oplaadtijd	22 min.	
Hard koppel	42 Nm	
Boorkop	1,5 - 13 mm	
Aantal accu's	2 x BL1830	
Gewicht	1,7 kg	
Prijs in €	Excl. BTW	
	Incl. BTW	

INCLUSIEF 96 ACCESSOIRES



ACCU BOORHAMERS SDS-PLUS

HEPA filter

DHR243RTJV

De afzuigunit bevat een aanzuigwaaier voor actieve stofafzuiging, aangedreven door een eigen motor die gevoed wordt door de accu van de boorhamer en enkele seconden blijft nalopen na het stopzetten van de boorhamer om alle reststof op te zuigen.



DHR171RTJ

BL MOTOR



DHR243RTJ

BL MOTOR



DHR243RTJV

BL MOTOR

Led accu werklamp ter waarde van € 49,00 bij DHR243RTJ / RTJV



NIEUW

	DHR165RTJ	DHR171RTJ	DHR164RMJ	DHR202RTJ	DHR243RTJ	DHR243RTJV
Batterijcapaciteit	18 V / 5,0 Ah	18 V / 5,0 Ah	14,4 V / 4,0 Ah	18 V / 5,0 Ah	18 V / 5,0 Ah	18 V / 5,0 Ah
Gemiddelde oplaadtijd	45 min.	45 min.	36 min.	45 min.	45 min.	45 min.
Slagenergie	1,3 J	1,2 J	1,3 J	2 J	2 J	2 J
Optimale Ø beton	6 - 8 mm	4 - 8 mm	4 - 8 mm	6 - 10 mm	6 - 16 mm	6 - 16 mm
Aantal accu's	2 x BL1850	2 x BL1850	2 x BL1440	2 x BL1850	2 x BL1850	2 x BL1850
Gewicht	2,5 kg	2,1 kg	2,5 kg	3,5 kg	3,4 kg	4,8 kg
Prijs in €	Excl. BTW					
	Incl. BTW					

ACCU BOOR- EN BEITELHAMER LXT 2X18V VOOR SDS-PLUS 3 FUNCTIES



INCLUSIEF 1 automatische boorkop (194079-2)



INCLUSIEF Duo snellader DC18RD



DHR264PT2J

Batterijcapaciteit	2 x 18V / 5,0 Ah	
Gemiddelde oplaadtijd	2 x 45 min.	
Slagenergie	2,5 J	
Optimale Ø beton	6 - 16 mm	
Aantal accu's	2 x BL1850	
Gewicht	4,7 kg	
Opvolger van	DHR264PM2J	
Prijs in €	Excl. BTW	
	Incl. BTW	

ACCU BOOR- EN BEITELHAMER SDS-PLUS 3 FUNCTIES



INCLUSIEF
1 automatische boorkop
(194079-2) bij
BHR262TRDJ



BHR262RDJ



	BHR262RDJ	BHR262TRDJ
Batterijcapaciteit	36 V / 2,6 Ah	36 V / 2,6 Ah
Gemiddelde oplaadtijd	22 min.	22 min.
Slagenergie	2,5 J	2,5 J
Optimale Ø beton	6 - 16 mm	6 - 16 mm
Aantal accu's	2 x BL3626	2 x BL3626
Gewicht	4,6 kg	4,8 kg
Prijs in €	Excl. BTW	
	Incl. BTW	

ACCU SLAGSCHROEVENDRAAIERS



DTD170RTJ



DTD154RTJ



DTD155RTJ

Led accu werklamp
ter waarde van € 49,00
bij DTD155RTJ

DTD170 :
4-traps koppelinstelling
(soft - medium - hard - max).
Assist mode voor het vlot
aanzetten bij het schroeven.

DTD154 :
3-traps koppelinstelling.
(soft - medium - hard)

DTD154 / DTD170 :
Instelling voor
zelftappende schroeven.



	DTD152RM3J	DTD153RTJ	DTD134RMJ	DTD137RMJ	DTD154RTJ	DTD155RTJ	DTD170RTJ
Batterijcapaciteit	18 V / 4,0 Ah	18 V / 5,0Ah	14,4 V / 4,0 Ah	14,4 V / 4,0 Ah	18 V / 5,0 Ah	18 V / 5,0 Ah	18 V / 5,0 Ah
Gemiddelde oplaadtijd	36 min.	45 min.	36 min.	36 min.	45 min.	45 min.	45 min.
Toerental	0-2900 t.p.m.	0-3400 t.p.m.	0-2400 t.p.m.	0-3400 t.p.m.	0-3600 t.p.m.	0-3000 t.p.m.	0-3600 t.p.m.
Hard koppel / Bitopname	165 Nm / 1/4" hex.	170 Nm / 1/4" hex.	155 Nm / 1/4" hex.	170 Nm / 1/4" hex.	175 Nm / 1/4" hex.	140 Nm / 1/4" hex.	175 Nm / 1/4" hex.
Aantal accu's	3 x BL1840	2 x BL1850	2 x BL1440	2 x BL1440	2 x BL1850	2 x BL1850	2 x BL1850
Gewicht	1,5 kg	1,5 kg	1,4 kg	1,4 kg	1,5 kg	1,4 kg	1,5 kg
Opvolger van	-	DTD129RTJ	-	-	-	-	DTD148RTJ
Prijs in €	Excl. BTW						
	Incl. BTW						

ACCU HYBRIDE SLAGSCHROEVENDRAAIER



4 mode:
klopboren, boren
schroeven, slagschroeven



DTP141RTJ

Batterijcapaciteit	18 V / 5,0 Ah
Gemiddelde oplaadtijd	45 min.
Toerental	0-2700 t.p.m.
Aantal accu's	2 x BL1850
Gewicht	1,8 kg
Prijs in €	Excl. BTW
	Incl. BTW

HYDRAULISCHE ACCU IMPULSSCHROEVENDRAAIERS



DTS141RTJ



	DTS131RMJ	DTS141RTJ
Batterijcapaciteit	14,4 V / 4,0 Ah	18 V / 5,0 Ah
Gemiddelde oplaadtijd	36 min.	45 min.
Toerental	0-3000 t.p.m.	0-3200 t.p.m.
Hard koppel / Bitopname	40 Nm / 1/4" hex.	40 Nm / 1/4" hex.
Aantal accu's	2 x BL1440	2 x BL1850
Gewicht	1,4 kg	1,5 kg
Prijs in €	Excl. BTW	
	Incl. BTW	

ACCU HAakse
SLAGSCHROEVENDRAAIER



18V



DTL061RTJ

Batterijcapaciteit	18 V / 5,0 Ah
Gemiddelde oplaadtijd	45 min.
Toerental	0-2000 t.p.m.
Aantal accu's	2 x BL1850
Gewicht	1,8 kg
Prijs in €	Excl. BTW
	Incl. BTW

ACCU SLAGMOERSLEUTELS



14.4V 18V



DTW285RTJ

Led accu werklamp
ter waarde van € 49,00
bij model DTW285,
DTW450, DTW1001,
DTW1002



DTW1002RTJ

Koppelinstelling	DTW280	DTW281
1 (Laag)	80 Nm	80 Nm
2 (Middel)	175 Nm	175 Nm
3 (Maximum)	275 Nm	280 Nm

	DTW190RTJ	DTW280RMJ	DTW285RTJ	DTW450RTJ	DTW1001RTJ	DTW1002RTJ
Batterijcapaciteit	18 V / 5,0 Ah	14,4 V / 4,0 Ah	18 V / 5,0 Ah	18 V / 5,0 Ah	18 V / 5,0 Ah	18 V / 5,0 Ah
Gemiddelde oplaadtijd	45 min.	36 min.	45 min.	45 min.	45 min.	45 min.
Toerental	2300 t.p.m.	0-2200 t.p.m.	0-2100 t.p.m.	1600 t.p.m.	1600 t.p.m.	1800 t.p.m.
Hard koppel / Bitopname	190 Nm / 1/2" vierkant	275 Nm / 1/2" vierkant	280 Nm / 1/2" vierkant	440 Nm / 1/2" vierkant	1050 Nm / 3/4" vierkant	1000 Nm / 1/2" vierkant
Aantal accu's	2 x BL1850	2 x BL1440	2 x BL1850B	2 x BL1850	2 x BL1850	2 x BL1850
Gewicht	1,7 kg	1,6 kg	1,1 kg	3,5 kg	3,4 kg	3,3 kg
Prijs in €	Excl. BTW					
	Incl. BTW					

KRACHTDOPPEN 1/2" ZONDER PEN EN RING



B-52308

14-delige 1/2" lange krachtdoppenset
in een handig koffertje.
Inclusief pennen en O-ringen.

€ 109,00 EXCL. BTW
€ 131,89 INCL. BTW



Best. Nr.	Dop maat (mm)	Lengte (mm)	Prijs	
			Excl. BTW	Incl. BTW
B-52146	8	81,5		
B-52152	10	81,5		
B-52180	13	81,5		
B-52211	17	81,5		

ACCU SCHROEFAUTOMATEN



DFR550RTJ

	DFR550RTJ	DFR750RTE
Batterijcapaciteit	18 V / 5,0 Ah	18 V / 5,0 Ah
Gemiddelde oplaadtijd	45 min.	45 min.
Toerental	4000 t.p.m.	4000 t.p.m.
Ø Gipsplaatschroef	4,2 mm	4,2 mm
Schroeflengte	25-55 mm	45-75 mm
Aantal accu's	2 x BL1850	2 x BL1850
Gewicht	2,2 kg	2,1 kg
Opvolger van	DFR550RMJ	DFR750RME
Prijs in €	Excl. BTW	
	Incl. BTW	

ACCU SCHROEVENDRAAIERS



DFS452RAJ

Batterijcapaciteit	18 V / 2,0 Ah
Gemiddelde oplaadtijd	24 min.
Toerental	0-4000 t.p.m.
Aantal accu's	2 x BL1820
Gewicht	1,7 kg
Opvolger van	DFS451RMJ
Prijs in €	Excl. BTW
	Incl. BTW



ACCU HAAKSE BOORMACHINES



DDA340RMJ
DDA350RTJ



DDA351RTJ



DDA341RMJ
DDA351RTJ



DDA350RTJ

	DDA350RTJ	DDA351RTJ
Batterijcapaciteit	18 V / 5,0 Ah	18 V / 5,0 Ah
Gemiddelde oplaadtijd	45 min.	45 min.
Toerental	0-1800 t.p.m.	0-1800 t.p.m.
Hard koppel	13.7 Nm	13.7 Nm
Boorkop	1,5-10 mm	1,5-10 mm
Aantal accu's	2 x BL1850	2 x BL1850
Gewicht	1,8 kg	1,8 kg
Prijs in €	Excl. BTW	
	Incl. BTW	

ACCU MINIBRADPISTOOL



DBN500RTJ

Batterijcapaciteit	18 V / 5,0 Ah
Gemiddelde oplaadtijd	45 min.
Doorsnede nagel	1,2 mm
Lengte nagel	15-50 mm
Aantal accu's	2 x BL1850
Gewicht	3,5 kg
Prijs in €	Excl. BTW
	Incl. BTW



ACCU AFWERKINGSPISTOOL



DPT353RTJ

NIEUW

	DPT351RTJ	DPT353RTJ
Batterijcapaciteit	18 V / 5,0 Ah	18 V / 5,0 Ah
Gemiddelde oplaadtijd	45 min.	45 min.
Doorsnede nagel	0,6 mm	0,6 mm
Lengte nagel	18-35 mm	15-35 mm
Aantal accu's	2 x BL1850	2 x BL1850
Gewicht	2,1 kg	2,3 kg
Prijs in €	Excl. BTW	
	Incl. BTW	

ACCU NIETMACHINES



DST112RTJ

DST221: Aluminium magazijn

	DST220RMJ	DST112RTJ	DST221RTJ
Batterijcapaciteit	14,4 V / 4,0 Ah	18 V / 5,0 Ah	18 V / 5,0 Ah
Gemiddelde oplaadtijd	36 min.	45 min.	45 min.
Rugbreedte niet	10,5 mm	10 mm	10,5 mm
Lengte niet	10-22 mm	7-10 mm	10-22 mm
Aantal accu's	2 x BL1440	2 x BL1850	2 x BL1850
Gewicht	2,3 kg	2,5 kg	2,4 kg
Prijs in €	Excl. BTW		
	Incl. BTW		

ACCU HANDCIRKELZAGEN



DCS551RTJ

DCS551RTJ voor metaal



DHS680RTJ

Led accu werklamp ter waarde van € 49,00 bij DHS680RTJ



	Best. Nr.	Omschrijving	Prijs Excl. BTW	Prijs Incl. BTW
	B-47151	TCT zaagblad 150x20x32T		
	B-47167	TCT zaagblad 150x20x52T		
	B-47173	TCT zaagblad 150x20x60T		
	B-47189	TCT zaagblad 150x20x62T		

	DSS501RTJ	DHS680RTJ	DCS551RTJ	DHS630RTJ
Batterijcapaciteit	18 V / 5,0 Ah	18 V / 5,0 Ah	18 V / 5,0 Ah	18 V / 5,0 Ah
Gemiddelde oplaadtijd	45 min.	45 min.	45 min.	45 min.
Zaagdiepte (90°)	51 mm	57 mm	51 mm	66 mm
Ø Zaagblad	136 mm	165 mm	150 mm	165 mm
Aantal accu's	2 x BL1850	2 x BL1850	2 x BL1850	2 x BL1850
Gewicht	2,7 kg	3,3 kg	2,9 kg	3,5 kg
Prijs in €	Excl. BTW			
	Incl. BTW			

ACCU HANDCIRKELZAAG



DHS710PT2J

INCLUSIEF Duo snellader DC18RD



Batterijcapaciteit	18 V / 5,0 Ah
Gemiddelde oplaadtijd	45 min.
Zaagdiepte (45°)	49 mm
Ø Zaagblad	190 mm
Aantal accu's	2 x BL1850
Gewicht	4,7 kg
Prijs in €	Excl. BTW
	Incl. BTW

ACCU DECOUPEERZAGEN



DJV181RTJ



DJV182RTJ



	DJV181RTJ	DJV182RTJ
Batterijcapaciteit	18 V / 5,0 Ah	18 V / 5,0 Ah
Gemiddelde oplaadtijd	45 min.	45 min.
Aantal zaagbewegingen	800 - 3500 min-1	800 - 3500 min-1
Maximale capaciteit hout	135 mm	135 mm
Aantal accu's	2 x BL1850	2 x BL1850
Gewicht	2,5 kg	2,5 kg
Prijs in €	Excl. BTW	
	Incl. BTW	

ACCU RECIPROZAGEN



	DJR183RTJ	DJR186RTE	DJR187RTE
Batterijcapaciteit	18 V / 5,0 Ah	18 V / 5,0 Ah	18 V / 5,0 Ah
Gemiddelde oplaadtijd	45 min.	45 min.	45 min.
Aantal zaagbewegingen	0-3300 /min.	2800 /min.	3000 /min.
Maximale capaciteit hout	50 mm	255 mm	255 mm
Aantal accu's	2 x BL1850	2 x BL1850	2 x BL1850
Gewicht	1,6 kg	3,5 kg	3,4 kg
Prijs in €	Excl. BTW		
	Incl. BTW		

ACCU RECIPROZAAG LXT 2 X 18V



DJR360PT2
INCLUSIEF
Duo snellader DC18RD

NIEUW

	DJR360ZK	DJR360PT2
Batterijcapaciteit	2 x 18 V	2 x 18 V / 5,0 Ah
Gemiddelde oplaadtijd	45 min.	45 min.
Aantal zaagbewegingen	0-3000 /min.	0-3000 /min.
Maximale capaciteit hout	255 mm	255 mm
Aantal accu's	0	2 x BL1850
Gewicht	3,4 kg	4,6 kg
Prijs in €	Excl. BTW	
	Incl. BTW	

HCS RECIPROZAAGBLAD VOOR ISOLATIEMATERIAAL

	Best. Nr.	Nuttige lengte (mm)	Lengte (mm)	Verpakking (stuks)	Prijs	
					Excl. BTW	Incl. BTW
	B-52130	300	400	1		
	B-52124	250	305	2		
	B-52118	175	228	2		

ACCU LINTZAAG



ACCESSOIRES DPB181RME BI-METAAL ZAAGBLADEN

Geschikt voor plastic, gelegeerd en niet gelegeerd staal, inox, aluminium en composietmateriaal.

Breedte: 13 mm, Lengte: 835 mm, Dikte: 0,5 mm
5 stuks per verpakking

B-40543 - Tandafstand 1,8 mm
€ 51,00 excl. BTW

B-40559 - Tandafstand 1,4 mm
€ 51,00 excl. BTW

B-40565 - Tandafstand 1,1 mm
€ 51,00 excl. BTW



	DPB181RME	
Batterijcapaciteit	18 V / 4,0 Ah	
Gemiddelde oplaadtijd	36 min.	
Bandsnelheid max.	3.2m / sec.	
Aantal accu's	2 x BL1840	
Gewicht	3,7 kg	
Prijs in €	Excl. BTW	
	Incl. BTW	

TELESCOPISCHE DUBBELVERSTEKZAAG OP ACCU



INCLUSIEF
Duo snellader DC18RD



	DLS714PT2	
Batterijcapaciteit	18 V / 5,0 Ah	
Gemiddelde oplaadtijd	45 min.	
Zaagdiepte (90°)	52 mm	
Zaagbreedte (90°)	300 mm	
Ø Zaagblad	190 mm	
Aantal accu's	2 x BL1850	
Gewicht	13,0 kg	
Prijs in €	Excl. BTW	
	Incl. BTW	

ACCU LAMELLENFREES

MAX PAC **18V**



DPJ180RTJ

Batterijcapaciteit	18 V / 5,0 Ah
Gemiddelde oplaadtijd	45 min.
Toerental	6500 t.p.m.
Aantal accu's	2 x BL1850
Gewicht	3,2 kg
Prijs in €	Excl. BTW
	Incl. BTW

ACCU SCHAAF

MAX PAC **18V**



DKP180RTJ

Batterijcapaciteit	18 V / 5,0 Ah
Gemiddelde oplaadtijd	45 min.
Toerental	14000 t.p.m.
Maximale schaafbreedte	82 mm
Aantal accu's	2 x BL1850
Gewicht	3,4 kg
Prijs in €	Excl. BTW
	Incl. BTW

ACCU KITPISTOLEN

18V



INCLUSIEF
kokerhouder 600 ml
bij DCG180RAX

	DCG180RA	DCG180RAX
Batterijcapaciteit	18 V / 2,0 Ah	18 V / 2,0 Ah
Gemiddelde oplaadtijd	24 min.	24 min.
Maximale spuitdruk	5000N	5000N
Toerental max.	0-28 mm/sec	0-28 mm/sec
Aantal accu's	1 x BL1820	1 x BL1820
Gewicht	2,1 kg	2,4 kg
Opvolger van	DCG180RH	-
Prijs in €	Excl. BTW	
	Incl. BTW	

MULTIFUNCTIONEEL OSCILLEREND GEREEDSCHAP

MAX PAC **L.E.D.** **18V**



INCLUSIEF:
SET VAN 9 ACCESSOIRES,
30 SCHUURVELLEN, 1 AFZUIGSET

Gereedschapsloze
accessoireswissel



DTM51RTJX2

Batterijcapaciteit	18 V / 5,0 Ah
Gemiddelde oplaadtijd	45 min.
Toerental	6000-20000 /min.
Oscillatiehoek	3,2 °
Aantal accu's	2 x BL1850
Opvolger van	DTM51RMJx2
Prijs in €	Excl. BTW
	Incl. BTW

ACCU EXCENTERSCHUURMACHINE 125MM

MAX PAC **18V**



DBO180RTJ

Batterijcapaciteit	18 V / 5,0 Ah
Gemiddelde oplaadtijd	45 min.
Aantal schuurbewegingen	11000 /min.
Schuurvoet	123 mm
Aantal accu's	2 x BL1850
Gewicht	1,7 kg
Opvolger van	DBO180RMJ
Prijs in €	Excl. BTW
	Incl. BTW

ACCU HAAKSE SLIJPER



DGA508RTJ

DGA508RTJ & DGA505 zijn uitgerust met een lepelchakelaar



Bluetooth speaker DMR200 ter waarde van € 99,00 bij model DGA506 & DGA508



DGA506RTJ

DGA506 & DGA508 met heropstartbeveiliging & elektrische rem



DGA900PT2



KOMSCHIJVEN

Best. Nr.	Ø (mm)	Dikte (mm)	Ø asgat (mm)	Prijs	
				Excl. BTW	Incl. BTW
B-46327	115	1,4	22, 23		
B-46333	125	1,4	22, 23		

DOORSLIJPSCHIJVEN
METAAL INOX

Best. Nr.	Ø (mm)	Dikte (mm)	Ø asgat (mm)	Prijs	
				Excl. BTW	Incl. BTW
B-45727	115	0,8	22, 23		
B-45733	125	0,8	22, 23		



ADT De automatische snelheidscontrole zorgt ervoor dat men op elk moment het meest efficiënt slijpt: het toerental wordt automatisch aangepast aan de belasting.

AFT Meer controle door de elektrische motorrem die de machine dadelijk stopt bij loslaten van de schakelaar.

NIEUW

NIEUW

	DGA900ZK	DGA506RTJ	DGA508RTJ	DGA900PT2
Batterijcapaciteit	2 x 18V	18 V / 5,0 Ah	18 V / 5,0 Ah	2 x 18 V / 5,0 Ah
Gemiddelde oplaadtijd	-	45 min.	45 min.	45 min.
Ø schijf	230 mm	125 mm	125 mm	230 mm
Aantal accu's	0	2 x BL1850	2 x BL1850	2 x BL1850
Gewicht	5,2 kg	2,5 kg	2,5 kg	5,2 kg
Opvolger van	-	DGA504RTJ	DGA505RTJ	-
Prijs in €	Excl. BTW			
	Incl. BTW			

ACCU STEMPELSLIJPER



DGD800RTJ

Batterijcapaciteit	18 V / 5,0 Ah
Gemiddelde oplaadtijd	45 min.
Toerental	25000 t.p.m.
Ø spantang	8 mm
Aantal accu's	2 x BL1850
Gewicht	2,1 kg
Opvolger van	DGD800RMJ
Prijs in €	Excl. BTW
	Incl. BTW

ACCU KNABELSCHAAR



DJN161RTJ

Batterijcapaciteit	18 V / 5,0 Ah
Gemiddelde oplaadtijd	45min.
Aantal snijbewegingen max.	1900 /min.
Max. dikte staal	1,6 mm
Aantal accu's	2 x BL1850
Gewicht	2,2 kg
Opvolger van	DJN161RMJ
Prijs in €	Excl. BTW
	Incl. BTW

ACCU PLAATSCHAAR

MAX PAC 18V 4.0A LITHIUM-ION



Makita
PROFESSIONALS AT WORK



		DJS130RTJ
Batterijcapaciteit	18 V / 5,0 Ah	
Gemiddelde oplaadtijd	45 min.	
Aantal zaagbewegingen	2800 /min.	
Max. dikte staal	1,3 mm	
Aantal accu's	2 x BL1850	
Gewicht	2,4 kg	
Opvolger van	DJS130RMJ	
Prijs in €	Excl. BTW	
	Incl. BTW	

DRAADSTANGSNIJDER / HYDRAULISCHE BETONIJZERKNIPPER

18V 4.0A LITHIUM-ION



ADT



DSC250ZK

BL
MOTOR



NIEUW

		DSC162RM	DSC250ZK	DSC191RM
Batterijcapaciteit	18V / 4,0 Ah		18V	18V / 4,0 Ah
Gemiddelde oplaadtijd	36 min.		-	36 min.
Maximale snijcapaciteit	16 mm		10 - 25 mm	20 mm
Aantal accu's	1 x BL1840		0	1 x BL1840
Gewicht	6,5 kg		3,9 kg	10,5 kg
Prijs in €	Excl. BTW			
	Incl. BTW			

ACCU BETONTRILNAALDEN



DVR850RTE

		DVR350RTE	DVR450RTE	DVR850RTE
Batterijcapaciteit	18 V / 5,0 Ah		18 V / 5,0 Ah	18 V / 5,0 Ah
Gemiddelde oplaadtijd	45 min.		45 min.	45 min.
Lengte trilnaald	80 cm		120 cm	240 cm
Diameter trilnaald	25 mm		25 mm	25 mm
Aantal accu's	2 x BL1850		2 x BL1850	2 x BL1850
Gewicht	2,0 kg		2,3 kg	2,4 kg
Opvolger van	DVR350RME		DVR450RME	BVR850RME
Prijs in €	Excl. BTW			
	Incl. BTW			

VACUÛMPOMP



NIEUW

		VDP180Z
Nominale accu spanning	18 V	
Aantal bijgeleverde accu's	0	
Compressietype	Olie roterend (schoepen), eentraps	
Maximum debiet	50 l/min	
Eindvacuüm	20 Pa	
Gewicht	2,9 kg	
Prijs in €	Excl. BTW	
	Incl. BTW	

DLX2121J

18V



Batterijcapaciteit	18 V / 3,0 Ah	
Gemiddelde oplaadtijd	22 min.	
Aantal accu's	2 x BL1830	
Boorschroefmachine	DDF453	
Slagschroevendraaier	DTD129	
Batterijlader	DC18RC	
MAKPAC koffer	✓	
Prijs in €	Excl. BTW	
	Incl. BTW	

DLX2189TJ

18V

NIEUW



Batterijcapaciteit	18 V / 5,0 Ah	
Gemiddelde oplaadtijd	45 min.	
Aantal accu's	2 x BL1850	
Boorschroefmachine	DDF484	
Slagschroevendraaier	DTD153	
Batterijlader	DC18RC	
MAKPAC koffer	✓	
Prijs in €	Excl. BTW	
	Incl. BTW	

DLX2127MJ1

18V LITHIUM-ION 4.0Ah



Batterijcapaciteit	18 V / 4,0 Ah	
Gemiddelde oplaadtijd	36 min.	
Aantal accu's	3 x BL1840	
Boorschroefmachine	DDF482	
Slagschroevendraaier	DTD152	
Batterijlader	DC18RC	
MAKPAC koffer	✓	
Prijs in €	Excl. BTW	
	Incl. BTW	

DLX2191TJ

18V

NIEUW



Batterijcapaciteit	18 V / 5,0 Ah	
Gemiddelde oplaadtijd	45 min.	
Aantal accu's	2 x BL1850B	
Boorschroefmachine	DDF484	
Boorhamer	DHR243	
Batterijlader	DC18RC	
MAKPAC koffer	✓	
Prijs in €	Excl. BTW	
	Incl. BTW	

DLX2174TJ1

18V

NIEUW



Batterijcapaciteit	18 V / 5,0 Ah	
Gemiddelde oplaadtijd	45 min.	
Aantal accu's	3 x BL1850B	
Boorschroefmachine	DHP481	
Slagschroevendraaier	DTD153	
MAKPAC koffer	✓	
Batterijlader	DC18RC	
Prijs in €	Excl. BTW	
	Incl. BTW	

DLX2236TJ1

18V

NIEUW



Batterijcapaciteit	18 V / 5,0 Ah	
Gemiddelde oplaadtijd	45 min.	
Aantal accu's	3 x BL1850B	
Slagschroevendraaier	2 x DTD153	
Batterijlader	DC18RC	
MAKPAC koffer	✓	
Prijs in €	Excl. BTW	
	Incl. BTW	

DLX2235T3J

18V



Batterijcapaciteit	18 V / 5,0 Ah	
Gemiddelde oplaadtijd	45 min.	
Aantal accu's	3 x BL1850B	
Boorschroefmachine	DDF484	
OIS multi tool	DTM51	
Batterijlader	DC18RC	
MAKPAC koffer	✓	
Prijs in €	Excl. BTW	
	Incl. BTW	

DLX2157TJ1

18V



Batterijcapaciteit	18 V / 5,0 Ah	
Gemiddelde oplaadtijd	45 min.	
Aantal accu's	3 x BL1850B	
Boorschroefmachine	DHP481	
Haakse slijper 125mm	DGA506	
Batterijlader	DC18RC	
MAKPAC koffer	✓	
Prijs in €	Excl. BTW	
	Incl. BTW	

DLX4001FJ1

18V



Batterijcapaciteit	18 V / 3,0 Ah	
Gemiddelde oplaadtijd	22 min.	
Aantal accu's	4 x BL1830B	
Boorschroefmachine	DDF459	
Werkklamp	DEADML801	
Stofzuiger	DCL182	
USB adapter	DEAADP05	
Batterijlader	DC18RC	
MAKPAC koffer	✓	
Prijs in €	Excl. BTW	
	Incl. BTW	

DLX4090TJ1

18V



Batterijcapaciteit	18 V / 5,0 Ah	
Gemiddelde oplaadtijd	45 min.	
Aantal accu's	3 x BL1850B	
Boorschroefmachine	DHP481	
Slagschroevendraaier	DTD153	
Boorhamer	DHR243	
Haakse slijper 125mm	DGA506	
Batterijlader	DC18RC	
MAKPAC koffer	✓	
Prijs in €	Excl. BTW	
	Incl. BTW	

DLX5023TJ

18V



Batterijcapaciteit	18 V / 5,0 Ah	
Gemiddelde oplaadtijd	45 min.	
Aantal accu's	3 x BL1850B	
Boorschroefmachine	DHP481	
Slagschroevendraaier	DTD153	
Boorhamer	DHR243	
Cirkelzaag	DHS680	
Haakse slijper 125mm	DGA506	
Batterijlader	DC18RC	
MAKPAC koffer	✓	
Prijs in €	Excl. BTW	
	Incl. BTW	

DLX2086TJ

18V



Batterijcapaciteit	18 V / 5,0 Ah	
Gemiddelde oplaadtijd	45 min.	
Aantal accu's	3 x BL1850	
Haakse slijper 125mm	DGA505	
Stofzuiger	DVC860L	
Batterijlader	DC18RC	
MAKPAC koffer	✓	
Prijs in €	Excl. BTW	
	Incl. BTW	

DLX6078TJ1 / DLX6078TJ2

18V

**MAKPAC trolley
enkel bij model TJ2**



	DLX6078TJ1	DLX6078TJ2
Batterijcapaciteit	18 V / 5,0 Ah	18 V / 5,0 Ah
Gemiddelde oplaadtijd	45 min.	45 min.
Aantal accu's	3 x BL1850B	3 x BL1850B
Boorschroefmachine	DHP481	DHP481
Slagschroevendraaier	DTD153	DTD153
Cirkelzaag	DHS680	DHS680
Boorhamer	DHR243	DHR243
Haakse slijper 125mm	DGA506	DGA506
OIS multi tool	DTM51	DTM51
MAKPAC trolley	-	✓
Batterijlader	DC18RC	DC18RC
Prijs in €	Excl. BTW	
	Incl. BTW	

DLX1009TJ1 / DLX1009TJ2

18V

**MAKPAC trolley
enkel bij model TJ2**



	DLX1009TJ1	DLX1009TJ2
Batterijcapaciteit	18 V / 5,0 Ah	18 V / 5,0 Ah
Gemiddelde oplaadtijd	45 min.	45 min.
Aantal accu's	5 x BL1850B	5 x BL1850B
Boorschroefmachine	DHP481, DDA351	DHP481, DDA351
Slagschroevendraaier	DTD153	DTD153
Cirkelzaag	DHS680	DHS680
Reciprozaag	DJR183	DJR183
Schuurmachine	DBO180	DBO180
Wipzaag	DJV181	DJV181
Boorhamer	DHR243	DHR243
Haakse slijper 125mm	DGA506	DGA506
OIS multi tool	DTM51	DTM51
MAKPAC trolley	-	✓
Batterijlader	2 x DC18RC	2 x DC18RC
Prijs in €	Excl. BTW	
	Incl. BTW	



CXT

10.8V

14.4V

18V

DMR107
 € Excl. BTW
 € Incl. BTW



10.8V

14.4V

18V

DMR108
 € Excl. BTW
 € Incl. BTW

Bluetooth®



CXT

DMR200
 € Excl. BTW
 € Incl. BTW

RoboPRO



18V LITHIUM-ION

BL MOTOR

DRC200Z
 € Excl. BTW
 € Incl. BTW

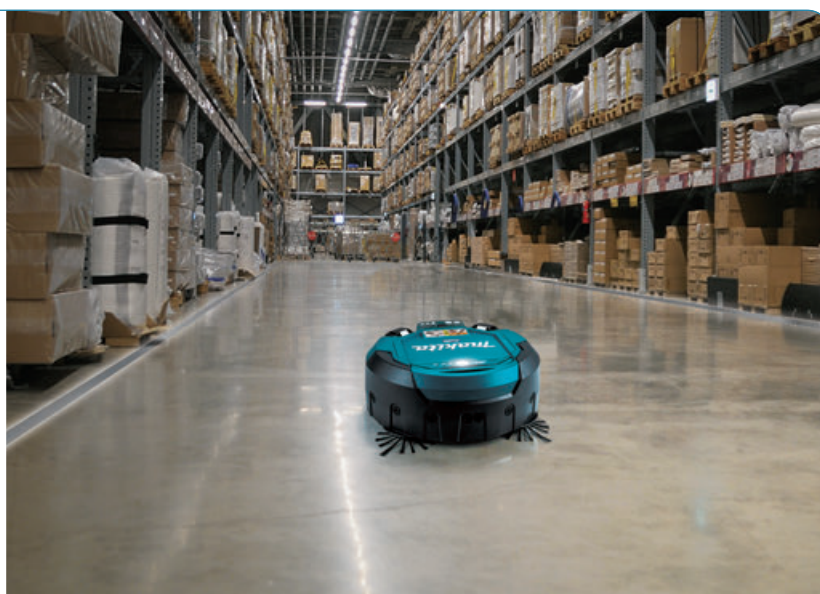

18V LITHIUM-ION

DCL182Z
 € Excl. BTW
 € Incl. BTW

18v + 18v → 36v

BL MOTOR



HEPA filter

DVC260Z
 € Excl. BTW
 € Incl. BTW

18v + 18v → 36v

HYBRID



DVC860LZ
 € Excl. BTW
 € Incl. BTW



**LED WERKLAMP
DEADML805**
€ Excl. BTW
€ Incl. BTW

STATIEF DML805
GM00001381



SPANVIJS DML805
GM00001396



USB ADAPTER 14,4 V / 18V
DEADP05



18V



DEADML185 Zaklamp
Accuspanning: 18V
Werkingsduur: 260 minuten

14.4V

18V



STEXBML186 Zaklamp
Accuspanning: 14,4V- 18V
Werkingsduur: 260 minuten

14.4V

18V



DEADML801 Zaklamp
Accuspanning: 14,4V - 18V
Werkingsduur: 9 uur

14.4V

18V



DEADML802 Zaklamp
Accuspanning: 14,4V - 18V
Werkingsduur: 13 uur

14.4V

18V



DEABML803 Zaklamp
Accuspanning: 14,4V - 18V
Werkingsduur: 16-24 uur

10.8V



STEXMR051
Radio LI-ION 10,8V

14.4V

18V



DEADML184 Zaklamp
Accuspanning: 14,4V - 18V
Werkingsduur: 200 minuten



STEXBML360 Zaklamp
Accuspanning: 36V
Werkingsduur: 210 min.

36V

14.4V

18V



BCF050Z
Ventilator voor helm
Li-Ion 14,4V - 18V

18V LITHIUM-ION



DSD180
DJV182
DJV181

DCO180
DTW1001
DTW1002

DHS630 / DHS680
DSS501 / DSS610

DTM51
DKP180

DPJ180

DBO180

DGD800

DGA505
DGA506
DGA508

DJN161

DJS130

DPB181

DJR186
DJR187

DCS551

DSC162
DSC191

DHR243
DHR202
DHR165

DTL061

DFR550
BFR750

DDA351
DDA350

DFS452
DFS250

DTW190
DTW281
DTW285
DTW450

DTD152
DTD153
DTD154
DTD170

DTS141
DTP141

DJR360

DLS714

DHS710

DHR264

DUB362

DUH551 / DUH651

18V + 18V 36V

DUR365U

DUR364L

DUC302
DUC353
DUC252

DLM380

DVC860L
DVC863LZ

DVC260



3.0Ah BL1830 22min



45min 36min 24min 15min
5.0Ah BL1850 4.0Ah BL1840 2.0Ah BL1820 1.5Ah BL1815N



DBN500 DST221 DPT351

DUC122 DCG180

DVR850
DVR450
DVR350

DVC350

DUB182

DUH483
DUH523

DUM168

DUP361

DUR182L
DUR182U
DUR184L

DUR181

DCL501

DCL182

DCF050

DMR050

DEADML802
DEABML803

STEXBML801

DMR107
DMR108
DRM110

DCF300

DFJ201
DFJ202
DFJ203
DFJ300
DFJ301
DFJ400
DFJ401

DDF083
DDF481
DDF482
DDF483
DDF484
DDF453



DCM500



WWW.MAKITA.BE



DHP481

DHP453
DHP484



© MAKITA 2017

SCHROEFBITSETS

11-delige 'standaard' schroefbits

D-30651



Inhoud: 25mm schroefbits PH1, PH2, PH3, PZ1, PZ2, PZ3, T15, T20, T25, T30 en een magnetische bithouder van 60mm.

37-delige 'standaard' schroefbitset

B-28606



Inhoud: 25mm 'standard' schroefbits PH0, PH1, 2 x PH2, PH3, PZ0, PZ1, 2 x PZ2, PZ3, T10, 2 x T15, 2 x T20, 2 x T25, T27, 2 x T30, T40, TH10, TH15, TH20, TH25, TH27, TH30, TH40, Hex3, Hex4, Hex5, Hex6, 0,5x4, 0,6x4,5, 1,0x5,5, 1,2x6,5 en een magnetische bithouder.



47-delige 'standaard' schroefbitset

B-36170



Inhoud: 25mm 'standard' schroefbits 2x PH1, 2 x PH2, 2x PH3, 2x PZ1, 2 x PZ2, 2x PZ3, 2x T10, 2 x T15, 2 x T20, 2 x T25, 2 x T30, 2x T40, Hex2, Hex2,5, Hex3, 2x Hex4, 2x Hex5, 2x Hex6, 2x 0,6x4,5, 2x 1,0x5,5, 2x 1,2x6,5, een magnetische bithouder, dopsleutels 5/6/7/8/9/10/11mm en een bithandgreep.

12-delige 'standaard' schroefbits

D-31083



Inhoud: 25mm schroefbits PH1, PH2, PH3, PZ1, PZ2, PZ3, T10, T15, T20, T25, T30 en een magnetische bithouder van 60 mm.

31-delige 'standaard' schroefbitset

D-30667



Inhoud: een 'quick-release' bithouder met 25mm 'standard' schroefbits 2x PH1, 4x PH2, 1x PH3, 2x PZ1, 5x PZ2, 1x PZ3, 2x T10, 2x T15, 2x T20, 3x T25, 2x T30, 1x T40, 1x 0,6x4,5, 1x 0,8x5,5 en 1x 1,2x6,5

BOORHAMERS SDS-PLUS 2 FUNCTIES

		HR1830	HR2600	HR2800
Vermogen		440 Watt	800 Watt	800 Watt
Slagenergie		1,2 J	2,4 J	2,8 J
Optimale Ø beton		4 - 8 mm	6 - 18 mm	8 - 18 mm
Vibratieniveau hamerboren		14 m/s ²	15,5 m/s ²	20 m/s ²
Gewicht		1,9 kg	2,8 kg	3,4 kg
Prijs in €	Excl. BTW			
	Incl. BTW			



BOOR- EN BEITELHAMERS SDS-PLUS 3 FUNCTIES



automatische boorkop bij HR2630X7 ter waarde van € 66,50

boor -en beitelset 17 stuks bij HR2470FT, HR2630TX12 & HR2631FT12 ter waarde van € 38,00



		HR2470	HR2630X7	HR2470FT	HR2630TX12	HR2631FT12	HR2811FT
Vermogen		780 Watt	800 Watt	780 Watt	800 Watt	800 Watt	800 Watt
Slagenergie		2,4 J	2,4 J	2,4 J	2,4 J	2,4 J	2,9 J
Optimale Ø beton		8 - 18 mm	6 - 18 mm	8 - 18 mm	6 - 18 mm	6 - 18 mm	8 - 18 mm
Vibratieniveau hamerboren		15,5 m/s ²	15 m/s ²	15,5 m/s ²	15 m/s ²	11,5 m/s ²	15 m/s ²
Gewicht		3,0 kg	3,0 kg	3,0 kg	2,9 kg	3 kg	3,6 kg
Opvolger van		-	-	-	HR2610TX9	HR2611FTX9	-
Prijs in €	Excl. BTW						
	Incl. BTW						

BOOR- EN BEITELHAMERS SDS-PLUS 3 FUNCTIES



INCLUSIEF 1 automatische boorkop (194568-7) bij HR3210FCT



		HR3200C	HR3210FCT
Vermogen		850 Watt	850 Watt
Slagenergie		5,1 J	4,9 J
Optimale Ø beton		10 - 22 mm	10 - 22 mm
Vibratieniveau hamerboren		18 m/s ²	10 m/s ²
Gewicht		4,8 kg	5,4 kg
Prijs in €	Excl. BTW		
	Incl. BTW		

SDS+ V-PLUS betonboren

SDS+ V-PLUS betonboren met 2 snijvlakken. Door de agressieve hardmetalen boorpunt glijdt deze boor door beton. De gepatenteerde meervoudige groeven zorgen voor een uitstekende afvoer van het boorgruis.

Best. Nr.	Ø (mm)	Lengte (mm)	Prijs	
			Excl. BTW	Incl. BTW
B-47232	4	110		
B-46492	5	110		
B-46501	5	160		
B-47298	5,5	110		
B-47307	5,5	110		
B-46517	6	110		
B-46523	6	160		
B-47341	6	210		
B-47357	6	260		
B-47385	6,5	110		
B-47391	6,5	160		
B-47400	6,5	210		
B-47416	6,5	260		
B-47438	7	110		
B-47444	7	160		
B-47450	7	210		
B-46539	8	110		
B-46545	8	160		
B-47472	8	210		
B-47488	8	260		
B-47503	8	400		
B-47519	8	460		
B-47525	8	600		
B-47531	9	160		
B-47547	9	210		
B-47553	9,5	160		
B-51409	9,5	310		
B-46551	10	110		
B-46567	10	160		
B-47569	10	210		
B-47575	10	260		
B-47581	10	310		
B-47606	10	450		
B-47612	10	600		
B-47634	10	1000		
B-47640	11	160		
B-47656	11	210		
B-47662	11	260		
B-46573	12	160		
B-47684	12	210		
B-47690	12	260		
B-47709	12	310		
B-47721	12	450		
B-47737	12	600		
B-47759	12	1000		

Best. Nr.	Ø (mm)	Lengte (mm)	Prijs	
			Excl. BTW	Incl. BTW
B-47765	13	160		
B-47771	13	210		
B-47787	13	260		
B-47793	13	310		
B-46589	14	160		
B-47802	14	210		
B-47818	14	260		
B-47824	14	310		
B-47830	14	450		
B-47846	14	600		
B-47852	14	1000		
B-47868	15	160		
B-47874	15	210		
B-47880	15	260		
B-47896	15	450		
B-47905	16	160		
B-47911	16	210		
B-47933	16	310		
B-47949	16	450		
B-47955	16	600		
B-47961	16	800		
B-47977	16	1000		
B-47983	17	210		
B-48000	18	200		
B-48016	18	300		
B-48022	18	450		
B-48038	18	600		
B-48044	18	1000		
B-48050	19	200		
B-48066	19	450		
B-48072	20	200		
B-48088	20	300		
B-48094	20	450		
B-48103	20	600		
B-48125	20	1000		
B-48131	22	250		
B-48147	22	450		
B-48153	22	600		
B-48169	22	1000		
B-48175	23	250		
B-48197	24	250		
B-48206	24	450		
B-48228	25	250		
B-48234	25	450		
B-48262	26	250		
B-48278	26	450		



Set van 5 SDS+ betonboren 2-FORCE B-49052



- 5 mm x 110 mm
- 6 mm x 110 mm
- 6 mm x 160 mm
- 8 mm x 110 mm
- 8 mm x 160 mm

Set van 7 SDS+ betonboren 2-FORCE B-49046



- 5 mm x 110 mm
- 6 mm x 110 mm
- 6 mm x 160 mm
- 8 mm x 110 mm
- 8 mm x 160 mm
- 10 mm x 160 mm
- 12 mm x 160 mm

Set van 12 SDS+ betonboren 2-FORCE P-67206



- 5 mm x 110 mm (4)
- 6 mm x 160 mm (5)
- 8 mm x 160 mm (3)

Set van 5 SDS+ betonboren 2-FORCE P-67169



- 5 mm x 110 mm
- 6 mm x 160 mm
- 8 mm x 160 mm
- 10 mm x 160 mm
- 12 mm x 160 mm

Set van 12 SDS+ betonboren 2-FORCE P-67175



- 6 mm x 110 mm
- 6 mm x 160 mm (2)
- 8 mm x 160 mm (3)
- 10 mm x 160 mm (2)
- 12 mm x 160 mm (2)
- 14 mm x 160 mm
- 16 mm x 160 mm

Set van 12 SDS+ betonboren 2-FORCE P-67197



- 6 mm x 160 mm (3)
- 8 mm x 160 mm (4)
- 10 mm x 160 mm (3)
- 12 mm x 160 mm (2)

BOOR- EN BREEKHAMERS AVT SDS-MAX 3 FUNCTIES



Boor en- beitelhamer HR2470FTP bij C modellen uitgezonderd HR3541FCX ter waarde van € 199,00



Bedrijfsstofzuiger L-klasse VC3011L bij CV modellen ter waarde van € 219,00

CV modellen inclusief stofafzuigset



	HR3541FCX	HR4013C	HR4013CV	HR4511C	HR4511CV	HR5212C	HR5212CV
Vermogen	850 watt	1100 Watt	1100 Watt	1350 Watt	1350 Watt	1500 Watt	1500 Watt
Slagenergie	5,7 J	8,0 J	8,0 J	9,4 J	9,4 J	18,9 J	18,9 J
Optimale Ø beton	14-25 mm	16-30 mm	16-30 mm	20-35 mm	20-35 mm	25-40 mm	25-40 mm
Vibratieniveau hamerboren	11 m/s ²	5,0 m/s ²	5,0 m/s ²	7,5 m/s ²	7,5 m/s ²	12,5 m/s ²	12,5 m/s ²
Gewicht	5,6 kg	6,8 kg	6,8 kg	8,8 kg	8,8 kg	12,1 kg	12,1 kg
Prijs in €	Excl. BTW						
	Incl. BTW						

STOF AFZUIGSET VOOR BOOR- EN BREEKHAMERS

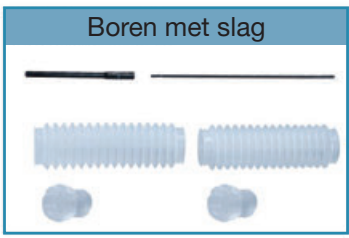

De afzuiging is aangesloten op het handvat van de boor- en breekhamer.

		196535-8	195866-2	196861-5
		HR4013C	HR4511C	HR5212C
Prijs in €	Excl. BTW			
	Incl. BTW			



SOFT NO LOAD

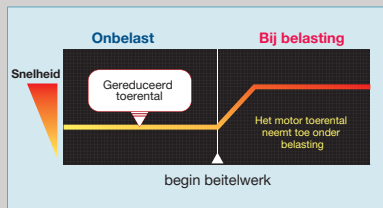

Het toerental van de machine automatisch gereduceerd bij nullast om onwelkome vibraties nog verder te reduceren.

BREEKHAMERS SDS-MAX

AVT
ANTI VIBRATION TECHNOLOGY

HM1213C



SOFT NO LOAD

Reductie toerental bij nullast



Bedrijfsstofzuiger L-klasse VC3011L bij CV modellen ter waarde van € 219,00



beitelset SDS-MAX 5 stuks bij C-modellen ter waarde van € 80,00



HM1214C



AVT
ANTI VIBRATION TECHNOLOGY

CV modellen inclusief stofafzuigset



	HM0870C	HM0870CV	HM0871C	HM0871CV	HM1101C	HM1101CV
Vermogen	1100 Watt	1100 Watt	1100 Watt	1100 Watt	1300 Watt	1300 Watt
Slagfrequentie	1100-2650 /min.	1100-2650 /min.	1100-2650 /min.	1100-2650 /min.	1100-2600 /min.	1100-2600 /min.
Slagenergie	7,6 J	7,6 J	8,1 J	8,1 J	11,5 J	11,5 J
Triax vibratie beitelen (ah)	11,5 m/s ²	11,5 m/s ²	8 m/s ²	8 m/s ²	13,5 m/s ²	13,5 m/s ²
Gewicht	5,1 kg	5,1 kg	5,8 kg	5,8 kg	7 kg	7 kg
Prijs in €	Excl. BTW					
	Incl. BTW					

	HM1111C	HM1111CV	HM1203C	HM1203CV	HM1213C	HM1213CV	HM1214C	HM1214CV
Vermogen	1300 Watt	1300 Watt	1510 Watt	1510 Watt	1510 Watt	1510 Watt	1510 Watt	1510 Watt
Slagfrequentie	1100-2600 /min.	1100-2600 /min.	950-1900 /min.	950-1900 /min.	950-1900 /min.	950-1900 /min.	950-1900 /min.	950-1900 /min.
Slagenergie	11,2 J	11,2 J	19,1 J	19,1 J	18,6 J	18,6 J	19,9 J	19,9 J
Triax vibratie beitelen (ah)	8 m/s ²	8 m/s ²	15,5 m/s ²	15,5 m/s ²	7 m/s ²	7 m/s ²	8 m/s ²	8 m/s ²
Gewicht	7,7 kg	7,7 kg	9,7 kg	9,7 kg	10,8 kg	10,8 kg	12,3 kg	12,3 kg
Prijs in €	Excl. BTW							
	Incl. BTW							

STOF AFZUIGSET VOOR BEITELN



Voor:
HM0870C, HM0871C
HM1101C, HM1111C
HM1203C, HM1213C
HM1214C

		196572-2
Prijs in €	Excl. BTW	
	Incl. BTW	

BIKHAMER SDS-PLUS

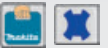

Makita
PROFESSIONALS AT WORK

	HK0500	HK1820
Vermogen	550 Watt	550 Watt
Slagfrequentie	2000-3500 /min.	0-3200 /min.
Slagenergie	1,8 J	3,1 J
Triaxiale vibratiewaarde (ah)	9,5 m/s ²	10 m/s ²
Gewicht	3,2 kg	3,4 kg
Prijs in €	Excl. BTW	
	Incl. BTW	

BREEKHAMERS MET ZESKANTOPNAME

SOFT NO LOAD

Reductie toerental bij nullast

Trolley ter waarde van € 72,00 bij HM1812



HM1812



AVT
ANTI VIBRATION TECHNOLOGY



HM1400



HM1317C



	HM1317C	HM1400	HM1812
Vermogen	1510 Watt	1240 Watt	2000 Watt
Slagfrequentie	730-1450 /min.	1200 /min.	870 /min.
Slagenergie	25 J	29,5 J	72,8 J
Bitopname hex.	30 mm	30 mm	28,6 mm
Gewicht	17 kg	18,1 kg	31,3 kg
Prijs in €	Excl. BTW		
	Incl. BTW		

KLOPBOORMACHINES



	HP1631KSP	HP2051FHJ	HP2071FJ
Vermogen	710 Watt	720 Watt	1010 Watt
Toerental	0-3200 t.p.m.	0-2900 t.p.m.	0-2900 t.p.m.
Ø Max. staal	13 mm	13 mm	18 mm
Ø Max. hout	30 mm	40 mm	40 mm
Ø Max. steen	16 mm	20 mm	20 mm
Boorkop	1,5-13 mm	1,5-13 mm	1,5-13 mm
Gewicht	2 kg	2,5 kg	2,6 kg
Prijs in €	Excl. BTW		
	Incl. BTW		

BOORMACHINES (MET 2 SNELHEDEN)



DP4011
Met 2 snelheden

	DP2011	DP4011	DP4003
Vermogen	370 Watt	720 Watt	750 Watt
Toerental	0-4200 t.p.m.	0-2900 t.p.m.	0-700 t.p.m.
Ø Max. staal	6,5 mm	13 mm	13 mm
Ø Max. hout	15 mm	40 mm	38 mm
Boorkop	0,8 - 6,5 mm	1,5 - 13 mm	1,5 - 13 mm
Gewicht	1,1 kg	2,3 kg	2,4 kg
Prijs in €	Excl. BTW		
	Incl. BTW		

HAAKSE BOORMACHINES



	DA3010FJ	DA3011FJ
Vermogen	450 Watt	450 Watt
Toerental	0-2400 t.p.m.	0-2400 t.p.m.
Ø Max. staal	10 mm	10 mm
Ø Max. hout	25 mm	25 mm
Boorkop	1 - 10 mm	1 - 10 mm
Gewicht	1,6 kg	1,6 kg
Prijs in €	Excl. BTW	
	Incl. BTW	



KERNBOORMACHINE MET MAGNEETVOET



	HB500	
Vermogen	1150 Watt	
Toerental	650 t.p.m.	
Ø Max. staal	50 mm	
Klemkracht magneetvoet	9300 N	
Inhoud snijvloeiستoftank	350 ml	
Gewicht	18,5 kg	
Prijs in €	Excl. BTW	
	Incl. BTW	

DIAMANTKERNBOORMACHINE (MET BOORSTANDAARD)



DBM230W

DBM131W / DBM230W
Geleverd met boorstandaard

	DBM131	DBM131W	DBM230W
Vermogen	1700 Watt	1700 Watt	2500 Watt
Toerental onbelast 1	1100 t.p.m.	1100 t.p.m.	390 t.p.m.
Toerental onbelast 2	-	-	1040 t.p.m.
Toerental	2300 t.p.m.	2300 t.p.m.	1700 t.p.m.
Toerental belast max.	1570 t.p.m.	1570 t.p.m.	1250 t.p.m.
Ø Max. beton	132 mm	132 mm	230 mm
Gewicht	6,1 kg	6,1 kg	6,9 kg
Prijs in €	Excl. BTW		
	Incl. BTW		

MENGRS



	UT1400	UT1401	UT1600
Vermogen	1300 Watt	1300 Watt	1800 Watt
Toerental onbelast max.	0-900 t.p.m.	0-730 t.p.m.	0-970 t.p.m.
Toerental belast max.	0-580 t.p.m.	0-450 t.p.m.	0-580 t.p.m.
Schroefdraad spindel	M14	M14	M14
Gewicht	5,2 kg	5,5 kg	7,1 kg
Prijs in €	Excl. BTW		
	Incl. BTW		



BOORMACHINE / MENGER

750 Watt



	DS4012	
Vermogen	750 Watt	
Toerental	600 t.p.m.	
Ø Max. staal	13 mm	
Ø Max. hout	36 mm	
Boorkop	2 - 13 mm	
Gewicht	2,8 kg	
Opvolger van	DS4011	
Prijs in €	Excl. BTW	
	Incl. BTW	

SCHROEFAUTOMATEN



		6844
Vermogen	470 Watt	
Toerental	3000 t.p.m.	
Ø Gipsplaat Schroef	4,2 mm	
Schroeflengte	45-75 mm	
Gewicht	2 kg	
Prijs in €	Excl. BTW	
	Incl. BTW	

SCHROEFMACHINES VOOR GIPSPLAAT



Geschikt voor gipsplaten op metalen profielen



INCLUSIEF : Quick lock kabel 4m



		FS4000K	FS6300RK
Vermogen	570 Watt		570 Watt
Toerental	0-4000 t.p.m.		0-6000 t.p.m.
Ø Gipsplaat Schroef	5 mm		5 mm
Gewicht	1,3 kg		1,4 kg
Opvolger	FS4000		-
Prijs in €	Excl. BTW		
	Incl. BTW		

SLAGMOERSLEUTELS



TW0350J



	TW0200J	TW0350J	6906J	TW1000
Vermogen	380 Watt	400 Watt	650 Watt	1300 Watt
Hard koppel	200 Nm	350 Nm	588 Nm	1000 Nm
Bitopname	1/2" vierkant	1/2" vierkant	3/4" vierkant	1" vierkant
Gewicht	2,2 kg	3 kg	5,6 kg	8,6 kg
Prijs in €	Excl. BTW			
	Incl. BTW			

KNABELSCHAAR



JN1601

Vermogen	550 Watt
Max. dikte staal	1,6 mm
Gewicht	1,6 kg
Prijs in €	Excl. BTW
	Incl. BTW

(BOCHTEN) PLAATSCHAREN



JS1601J



JS3201J

	JS1601J	JS3201J
Vermogen	380 Watt	710 Watt
Aantal zaagbewegingen	4500 /min.	1600 /min.
Max. dikte staal	1,6 mm	3,2 mm
Gewicht	1,4 kg	3,4 kg
Opvolger van	JS1601	-
Prijs in €	Excl. BTW	
	Incl. BTW	



NEBULA, ALL-ROUND LASERGELASTE DIAMANTSCHIJF

		Best. Nr.	Ø (mm)	Tanddikte (mm)	Prijs	
					Excl. BTW	Incl. BTW
		B-53992	125	2,0		
		B-54003	150	2,0		
		B-54025	230	2,4		
		B-54053	350	3,0		
		B-54069	400	3,0		

HAAKSE SLIJPERS 125 MM

720 Watt



GA5030RSP2

GA5030RK

	GA5030RK	GA5030RSP2
Vermogen	720 Watt	720 Watt
Toerental	11000 t.p.m.	11000 t.p.m.
Ø schijf	125 mm	125 mm
Gewicht	1,8 kg	1,8 kg
Prijs in €	Excl. BTW	
	Incl. BTW	

HAAKSE SLIJPERS 125 MM

840 Watt



9558HNRGK3

125 MM

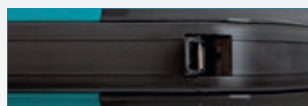

9558PBGY met dodemansschakelaar: motor schakelt uit bij loslaten van schakelaar voor verhoogde veiligheid

	9558HNRGZ	9558HNRGK3
Vermogen	840 Watt	840 Watt
Toerental	11000 t.p.m.	11000 t.p.m.
Ø schijf	125 mm	125 mm
Gewicht	2,1 kg	2,1 kg
Prijs in €	Excl. BTW	
	Incl. BTW	

STOFAFZUIGING VOOR 125MM SLIJPERS (196845-3)



€ 71,00 Excl. BTW
€ 85,91 Incl. BTW

HAAKSE SLIJPERS 125 MM

1100 Watt / 1400 Watt



GA5040RKDJ

GA5040CJD1

+ veiligheidsbril bij model GA5040CJD

GA5041TX2 MET MECHANISCHE MOTORREM

	GA5040RZ	GA5040RKDJ	GA5040C	GA5040CJD	GA5041TX2	GA5040CJD1
Vermogen	1100 Watt	1100 Watt	1400 Watt	1400 Watt	1100 Watt	1400 Watt
Toerental	11000 t.p.m.	11000 t.p.m.	2800-11000 t.p.m.	2800-11000 t.p.m.	11000 t.p.m.	2800-11000 t.p.m.
Ø schijf	125 mm	125 mm	125 mm	125 mm	125 mm	125 mm
Gewicht	2,4 kg	2,4 kg	2,4 kg	2,4 kg	2,6 kg	2,4 kg
Prijs in €	Excl. BTW					
	Incl. BTW					

HAAKSE SLIJPERS 125 MM

1400 Watt



9565PCV01



SA5040C



10 x inox doorslijp-schijven ter waarde van € bij 9565PCV01

9565PCV01 & 9566PCV01 : dodemansschakelaar = motor schakelt uit bij loslaten van schakelaar voor verhoogde veiligheid

	9565CRX1	9565PCV01	9566PCV01	SA5040C
Vermogen	1400 Watt	1400 Watt	1400 Watt	1400 Watt
Toerental	11000 t.p.m.	2800-11500 t.p.m.	4000-10000 t.p.m.	2000-7800 t.p.m.
Ø schijf	125 mm	125 mm	150 mm	125 mm
Gewicht	2,6 kg	2,6 kg	2,7 kg	2,2 kg
Prijs in €	Excl. BTW			
	Incl. BTW			

HAAKSE SLIJPERS 125 MM

1450 Watt



GA5021CY



10 x inox doorslijp-schijven ter waarde van €

GA5021C : MAKPOWER
GA5021CY : MAKPOWER & dodemansschakelaar

	GA5021C	GA5021CY
Vermogen	1450 Watt	1450 Watt
Toerental	10000 t.p.m.	10000 t.p.m.
Ø schijf	125 mm	125 mm
Gewicht	3 kg	3 kg
Prijs in €	Excl. BTW	
	Incl. BTW	

10 x Doorslijpschijven in blik



Best. Nr.	Ø (mm)	Dikte (mm)	Ø asgat (mm)	Prijs	
				Excl. BTW	Incl. BTW
D-18764-10	115	1,2	22, 23		
D-18770-10	125	1,2	22, 23		



HAAKSE SLIJPERS 180 MM

2200 Watt



	GA7060	
Vermogen	2000 Watt	
Toerental	8500 t.p.m.	
Ø schijf	180 mm	
Gewicht	5,3 kg	
Prijs in €	Excl. BTW	
	Incl. BTW	

HAAKSE SLIJPERS 230 MM

2000 Watt / 2200 Watt



		GA9050	GA9060	GA9061R
Vermogen		2000 Watt	2200 Watt	2200 Watt
Toerental		6600 t.p.m.	6600 t.p.m.	6600 t.p.m.
Ø schijf		230 mm	230 mm	230 mm
Gewicht		4,7 kg	5,6 kg	5,7 kg
Prijs in €	Excl. BTW			
	Incl. BTW			

GA9061R:
Anti-heropstart

HAAKSE SLIJPERS 230 MM

2400 Watt / 2600 Watt



		GA9030SF01	GA9030RF01	GA9040SF01	GA9040RF01
Vermogen		2400 Watt	2400 Watt	2600 Watt	2600 Watt
Toerental		6600 t.p.m.	6600 t.p.m.	6600 t.p.m.	6600 t.p.m.
Ø schijf		230 mm	230 mm	230 mm	230 mm
Gewicht		6,3 kg	6,5 kg	6,7 kg	6,9 kg
Prijs in €	Excl. BTW				
	Incl. BTW				

COMBOPACK SLIJPERS



		DK0047GX1
Haakse slijper 230mm 2200 Watt		GA9060
Haakse slijper 125mm 840 Watt		9558HNRG
Diamantslijpschijf		2x Diamak DS
Synthetische koffer		✓
Prijs in €	Excl. BTW	
	Incl. BTW	



COMBOPACK SLIJPERS



		DK0046X1
Haakse slijper 230mm 2200 Watt		GA9061R
Haakse slijper 125mm 1100 Watt		GA5040RZ
Diamantslijpschijf		2x Diamak DS
Synthetische koffer		✓
Prijs in €	Excl. BTW	
	Incl. BTW	



SLIJPMOLENS



		GB602W	GB801
Vermogen		250 Watt	550 Watt
Toerental		2850 t.p.m.	2850 t.p.m.
Ø Slijpsteen		150 mm	205 mm
Gewicht		9 kg	19,8 kg
Prijs in €	Excl. BTW		
	Incl. BTW		

AFKORTSLIJPMACHINE
355MM

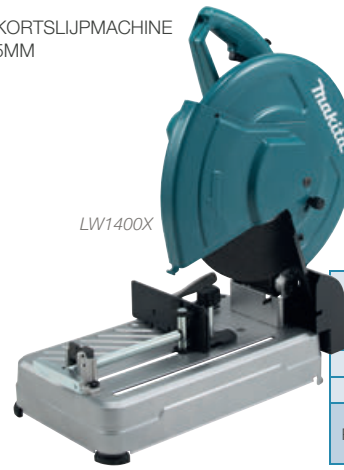

		LW1400X
Vermogen		2200 Watt
Toerental		3800 t.p.m.
Zaagdiepte (90°)		115 mm
Ø schijf		355 mm
Gewicht		17,2 kg
Prijs in €	Excl. BTW	
	Incl. BTW	

AFKORTMACHINE



		4131	LC1230
Vermogen		1100 Watt	1750 Watt
Toerental		3500 t.p.m.	1300 t.p.m.
Zaagdiepte (90°)		63 mm	100 mm
Ø Zaagblad		185 mm	305 mm
Gewicht		5,1 kg	19,3 kg
Prijs in €	Excl. BTW		
	Incl. BTW		

DRAAGBARE LINTZAAG



		2107FK
Vermogen		710 Watt
Bandsnelheid max.		1,8 m/sec.
Max. capaciteit stalen buis		120 mm
Max. zaagcapaciteit staal		30 mm
Gewicht		6,0 kg
Prijs in €	Excl. BTW	
	Incl. BTW	

PLATENFREES

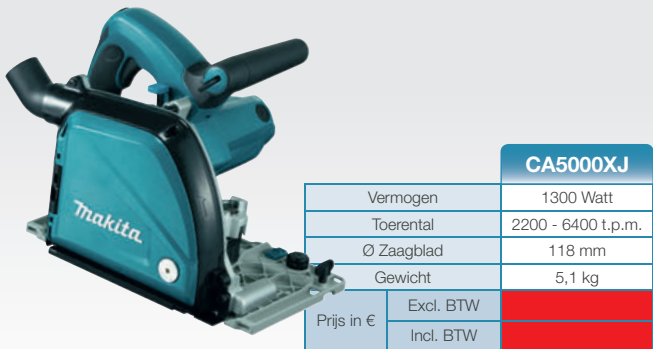

		CA5000XJ
Vermogen		1300 Watt
Toerental		2200 - 6400 t.p.m.
Ø Zaagblad		118 mm
Gewicht		5,1 kg
Prijs in €	Excl. BTW	
	Incl. BTW	

LINTZAAGMACHINE 305MM



JM21000330	€ 11,30 Excl. BTW
Adapterset voor schuurbanden.	€ 13,67 Incl. BTW
B-42581	
Schuurbanden 20x2240mm Red • Korrel 80	€ 12,30 Excl. BTW
B-42597	
Schuurbanden 20x2240mm Red • Korrel 120	€ 14,88 Incl. BTW

		LB1200F
Vermogen		900 Watt
Breedte zaaglint		6 - 16 mm
Gewicht		81,2 kg
Prijs in €	Excl. BTW	
	Incl. BTW	

STEMPELSLIJPEERS



		GD0600	GD0800C	GD0801C	GD0811C
Vermogen		400 Watt	750 Watt	750 Watt	750 Watt
Uitgangsvermogen		250 Watt	480 Watt	480 Watt	480 Watt
Toerental		25000 t.p.m.	7000-28000 t.p.m.	7000-28000 t.p.m.	1800-7000 t.p.m.
Maximum Ø spatang		6,35 mm	8 mm	8 mm	8 mm
Gewicht		1,7 kg	1,7 kg	1,7 kg	2,0 kg
Lepelschakelaar		✓	-	✓	✓
Prijs in €	Excl. BTW				
	Incl. BTW				

BETONSCHUURMACHINE
MET GELEIDEZOOl



		PC5001C
Vermogen		1400 Watt
Ø schijf		125 mm
Gewicht		5,1 kg
Prijs in €	Excl. BTW	
	Incl. BTW	

DIAMANTZAAG



		4114S
Vermogen		2400 Watt
Maximale slijpdiepte		125 mm
Ø schijf		350 mm
Ø asgat		25,4 mm
Gewicht		10,8 kg
Prijs in €	Excl. BTW	
	Incl. BTW	

SLEUVENSLIJPERS

2 x diamant
slijpschijven
bij SG150 & SG180



	SG1251J	SG150	SG180
Vermogen	1400 Watt	1800 Watt	1800 Watt
Max. slijpdiepte	30 mm	45 mm	60 mm
Sleufbreedte	6 - 30 mm	7 - 35 mm	7 - 43 mm
Ø schijf	125 mm	150 mm	180 mm
Gewicht	4,4 kg	5,7 kg	6 kg
Prijs in €	Excl. BTW		
	Incl. BTW		

DIAMANTZAAG



NIEUW

		4100KB
Vermogen		1400 W
Zaagdiepte (0°)		40 mm
Ø Zaagblad		125 mm
Gewicht		3,0 kg
Gewicht		10,8 kg
Prijs in €	Excl. BTW	
	Incl. BTW	

MOTORDOORSLIJPERS

MM4
MAKITA MINI 4-STROKE ENGINE

SLR
EK7301WS

3
JAAR
GARANTIE
OP MACHINES
Na registratie op
www.makita.be



	EK6100	EK7301WS	EK7651H
Motor	2-taktmotor	2-taktmotor	4-taktmotor
Cilinderinhoud	60,7 cc	72,6 cc	75,6 cc
Vermogen	3,2 kW / 4,3 pk	3,8 kW / 5,2 pk	3,0 kW / 4,1 pk
Maximaal netto koppel	3,9 Nm	4,3 Nm	4,6 Nm
Ø schijf	300 mm	350 mm	350 mm
Decompressieklep	-	✓	✓
Gewicht	8,5 kg	10 kg	12,9 kg
Prijs in €	Excl. BTW		
	Incl. BTW		

	DK0065WST	DK0040M	DK0069WST
Motordoorslijper	EK7301WS 2-taktmotor	EK7651H 4-taktmotor	EK8100WS 2-taktmotor
Haakse slijper	DGA506	DGA504RM	DGA506
Accu	1x BL1850B	1 x BL1840	1x BL1850B
Snellader	DC18RC	DC18RC	DC18RC
Prijs in €	Excl. BTW		
	Incl. BTW		

SCHAVEN



Elektronische toerentalregeling

	MAK PAC	MAK PAC	MAK PAC	Makita
	KP0800J	KP0810J	KP0810CJ	KP312S
Vermogen	620 Watt	850 Watt	1050 Watt	2200 Watt
Toerental	17000 t.p.m.	16000 t.p.m.	12000 t.p.m.	12000 t.p.m.
Breedte	82 mm	82 mm	82 mm	312 mm
Max. spaanafname	2,5 mm	4 mm	4 mm	3,5 mm
Gewicht	2,6 kg	3,3 kg	3,4 kg	18,4 kg
Prijs in €	Excl. BTW			
	Incl. BTW			

VANDIKTEBANK



	2012NB
Vermogen	1650 Watt
Toerental	8500 t.p.m.
Breedte	304 mm
Max. doorlaathoogte	155 mm
Max. spaanafname	3 mm
Gewicht	28,1 kg
Prijs in €	Excl. BTW
	Incl. BTW

KETTINGFREESMACHINE

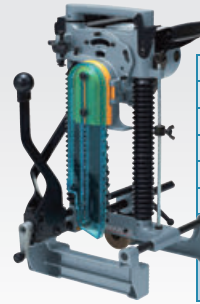

	7104L	7104L-30
Vermogen	1140 Watt	1140 Watt
Toerental	3200 t.p.m.	3200 t.p.m.
Kettingsnelheid onbelast	50 m/sec	50 m/sec
Ketting	16,5 mm	30 mm
Gatbreedte	16,5-30 mm	30-45 mm
Gatlengthe	54-130 mm	54-130 mm
Gewicht	17,3 kg	17,3 kg
Prijs in €	Excl. BTW	
	Incl. BTW	

CIRKELZAGEN

zaagblad bij 5008MGJX ter waarde van €



2 x zaagblad 12 tanden bij HS7101JX ter waarde van €
2 x zaagblad 16 tanden bij 5903RKX1 ter waarde van €









	HS6601	HS7601J	HS6101J	HS7101JX	5008MGJX	5903RKX1	HS0600	5103R	5143R
Vermogen	1050 Watt	1200 Watt	1100 Watt	1400 Watt	1800 Watt	2000 Watt	2000 Watt	2100 Watt	2200 Watt
Zaagdiepte (90°)	54,5 mm	66 mm	54,5 mm	67 mm	75,5 mm	85 mm	101 mm	100 mm	130 mm
Ø Zaagblad	165 mm	190 mm	165 mm	190 mm	210 mm	235 mm	270 mm	270 mm	355 mm
Gewicht	3,7 kg	4,0 kg	3,7 kg	4,0 kg	5,1 kg	7,2 kg	6,9 kg	9,4 kg	14,0 kg
Prijs in €	Excl. BTW								
	Incl. BTW								



ZAAGBLADEN

	Best. Nr.	Omschrijving	INFO	Prijs Excl. BTW	Prijs Incl. BTW
	B-42640	T.C.T. zaagblad 250x30x80T voor MDF	2704 LH1040 LH1200F		
	B-42656	T.C.T. zaagblad 300x30x96T voor MDF			
	B-45434	T.C.T. zaagblad 165x20x60T voor MDF	SP6000		
	B-46171	T.C.T. zaagblad 315x30x24T	2712		
	B-46187	T.C.T. zaagblad 315x30x48T	2712		

	Best. Nr.	Omschrijving	INFO	Prijs Excl. BTW	Prijs Incl. BTW
	B-46193	T.C.T. zaagblad 315x30x60T	2712		
	B-49301	T.C.T. zaagblad 165x20 48Tx56T	Twin Pack		
	B-49317	T.C.T. zaagblad 165x20 24Tx40T			
	B-49323	T.C.T. zaagblad 190x30 24Tx40T			
	B-49339	T.C.T. zaagblad 235x30 20Tx40T			

HANDCIKSELZAAGBLADEN

	Best. Nr.	Omschrijving	INFO	Prijs Excl. BTW	Prijs Incl. BTW
	B-08296	HM zaagblad 160x20x24D hout MAKFORCE	5603R 5604R HS6101		
	B-08420	HM zaagblad 160x20x40D hout MAKFORCE			
	B-08006	HM zaagblad 165x20x24D hout M-FORCE			
	B-09329	HM zaagblad 165x20x16D hout met nagels M-FORCE			
	B-13683	HM zaagblad 190x30x12D construction	5704R 5705R HS7101		
	B-08355	HM zaagblad 190x30x24D hout MAKFORCE			
	B-08486	HM zaagblad 190x30x40D hout MAKFORCE			

	Best. Nr.	Omschrijving	INFO	Prijs Excl. BTW	Prijs Incl. BTW
	B-09357	HM zaagblad 190x30x16D hout met nagels SPECIALIZED	5704R 5705R HS7101		
	B-27246	HM zaagblad 210x30x12D construction	5008MG		
	B-13699	HM zaagblad 235x30x16D construction	5903R		
	B-17675	HM zaagblad 235x30x50D SANDWICH panelen			
	B-17681	HM zaagblad 270x30x60D SANDWICH panelen	5103R		
	B-17697	LHM zaagblad 355x30x80D SANDWICH panelen	5143R		

HANDCIKSELZAAGBLADEN MAK SPECIALIZED HOUT MET NAGELS



Best. Nr.	Omschrijving	INFO	Prijs Excl. BTW	Prijs Incl. BTW
B-09329	TCT zaagblad 165x20x16T	5603R 5604R HS6101		
B-09472	TCT zaagblad 165x20x40T			
B-09357	TCT zaagblad 190x30x16T	5704R 5705R HS7101		
B-09503	TCT zaagblad 190x30x40T			
B-09438	TCT zaagblad 210x30x24T	5008MG		
B-09444	TCT zaagblad 235x30x24T	5903R		
B-09519	TCT zaagblad 235x30x48T			
B-09450	TCT zaagblad 270x30x24T	5103R		
B-09531	TCT zaagblad 270x30x60T			
B-09385	TCT zaagblad 355x30x24T	5143R		
B-09547	TCT zaagblad 355x30x60T			

DUIKZAAG 165 MM



2 x geleiderail 1,4 m
+ 1 x koppelstrip
ter waarde van €



		SP6000J1
Vermogen		1300 Watt
Zaagdiepte (90°)		57 mm
Zaagdiepte (45°)		40 mm
Maximale zaagdiepte (48°)		38 mm
Ø Zaagblad		165 mm
Gewicht		4,4 kg
Prijs in €	Excl. BTW	
	Incl. BTW	

TELESCOPISCHE DUBBEL-VERSTEKZAGEN

Onderstel DEAWST06
bij LS1019L / LS0714FLB
LS1016FLB / LS1216FLB
ter waarde van €

Model	DEAWST06 - Onderstel
LS0714	✓
LS0815	✓
LS1016	✓
LS1018	✓
LS1019	✓
LS1216	✓

Setbevestigingsklemmen voor het bevestigen van verstek-zagen op onderstel DEAWST06



LS1018L



LS1216FLB



LS1019L

NIEUW

Verstek-hoek	LS1216FLB - Snijhoek		
	45° links	90°	45° rechts
0°	69X363 mm	102X363 mm	54X363 mm
45° L EN R	69X255 mm	102X255 mm	54X255 mm
57° R	-	102X220 mm	-
PLINTEN	-	165 mm	-

Verstek-hoek	LS1019L - Snijhoek		
	45° links	0°	45° rechts
0°	61X279 mm	91X279 mm	43X279 mm
45° L EN R	61X197 mm	91X197 mm	43X197 mm
60° L EN R	-	91X139 mm	-
PLINTEN	-	133 mm	-

Verstek-hoek	LS0815FL - Snijhoek		
	0°	45° links	5° rechts
0°	65X305 mm	50X305 mm	60X305 mm
45° L EN R	65X215 mm	50X215 mm	-
60° R	65X150 mm	-	-

Verstek-hoek	LS0714FLB - Snijhoek		
	45° links	90°	45° rechts
0°	40X300 mm	52X300 mm	40X300 mm
45° L EN R	40X212 mm	52X212 mm	-
57° R	-	52X163 mm	-

DXT
Deep and Exact Cutting Technology

DEEP CUTTING

De gepatenteerde constructie met drievoudige tandwieloverbrenging en uitsparing achter de flens laat toe om een groter deel van het zaagblad te benutten, waardoor plinten tot 165mm hoogte verticaal kunnen worden afgekort of in verstek gezaagd.



LS0815FL

	LS0815FL	LS1040F	LS1018L
Vermogen	1400 Watt	1650 Watt	1430 Watt
Ø Zaagblad	216 mm	260 mm	260 mm
Gewicht	14,2 kg	12,4 kg	19,9 kg
Prijs in €	Excl. BTW		
	Incl. BTW		

	LS0714FLB	LS1019L	LS1216FLB
Vermogen	1010 Watt	1510 Watt	1650 Watt
Ø Zaagblad	190 mm	260 mm	305 mm
Gewicht	13,4 kg	26,3 kg	26,7 kg
Prijs in €	Excl. BTW		
	Incl. BTW		

TAFEL-, AFKORT- EN VERSTEEKZAGEN



Bluetooth speaker DMR200 bij modellen LH1040F & LH1201FL ter waarde van €



SNELLE OMBOUW VAN TAFEL- NAAR AFKORTZAAGFUNCTIE



Verstekhoek	LH1040	LH1200FL	LF1000
	90°	91 x 95 mm 69 x 130 mm	95 x 155 mm 62 x 200 mm
45°	69 x 85 mm	62 x 125 mm	30 x 95 mm

		LH1040F	LH1201FL	LF1000
Vermogen		1650 Watt	1650 Watt	1650 Watt
Ø Zaagblad		260 mm	305 mm	260 mm
Gewicht		14,3 kg	20,7 kg	36 kg
Opvolger van		-	LH1200FL	-
Prijs in €	Excl. BTW			
	Incl. BTW			

MAKBLADE SPECIALIZED HOUT MET NAGELS ZAAGBLADEN

	Best. Nr.	Omschrijving	INFO	Prijs Excl. BTW	Prijs Incl. BTW
	B-40587	T.C.T. zaagblad 190x20x24T	LS0714FLB		
	B-40593	T.C.T. zaagblad 190x20x40T			
	B-40602	T.C.T. zaagblad 216x30x24T	LS0815FL		
	B-40618	T.C.T. zaagblad 216x30x40T			

Best. Nr.	Omschrijving	INFO	Prijs Excl. BTW	Prijs Incl. BTW
B-40624	T.C.T. zaagblad 260x30x32T	LS1018L LS1019L LS1016FLB		
B-40630	T.C.T. zaagblad 260x30x64T			
B-40646	T.C.T. zaagblad 305x30x32T		LS1216FLB	
B-40652	T.C.T. zaagblad 305x30x60T	LH1201FL		

TAFELZAAG MET ONDERSTEL



		2704W
Vermogen		1650 Watt
Ø Zaagblad		260 mm
Gewicht		34,9 kg
Prijs in €	Excl. BTW	
	Incl. BTW	

TAFELZAAG



		MLT100
Vermogen		1500 Watt
Ø Zaagblad		260 mm
Gewicht		34,7 kg
Prijs in €	Excl. BTW	
	Incl. BTW	



BOUWCIRKELZAAG MET INDUCTIE MOTOR



		2712
Vermogen		2000 Watt
Ø Zaagblad		315 mm
Gewicht		52,9 kg
Prijs in €	Excl. BTW	
	Incl. BTW	

WIPZAGEN



	4326	4329K	JV0600J	4350FCTJ	4351FCTJ
Vermogen	450 Watt	450 Watt	650 Watt	720 Watt	720 Watt
Aantal zaagbewegingen	3100 /min.	500-3100 /min.	500-3100 /min.	800-2800 /min.	800-2800 /min.
Maximale capaciteit hout	65 mm	65 mm	90 mm	135 mm	135 mm
Gewicht	1,8 kg	1,9 kg	2,4 kg	2,6 kg	2,5 kg
Prijs in €	Excl. BTW				
	Incl. BTW				

RECIPROZAGEN



AVT
ANTI VIBRATION TECHNOLOGY



Bluetooth speaker DMR200 bij model JR3070CT ter waarde van €



JR3070CT

	JR3050T	JR3060T	JR3070CT
Vermogen	1010 Watt	1250 Watt	1510 Watt
Aantal zaagbewegingen	0-2800 /min.	0-2800 /min.	0-2800 /min.
Maximale capaciteit hout	90 mm	255 mm	255 mm
Technologie	Varioschakelaar	Pendelinstelling Varioschakelaar	Avt systeem Regelbaar toerental in 6 posities Pendelinstelling Varioschakelaar
Vibratieniveau	22 m/s ²	23,5 m/s ²	8,5 m/s ²
Gewicht	3,2 kg	4,2 kg	4,4 kg
Prijs in €	Excl. BTW		
	Incl. BTW		



BOVENFREZEN



Bluetooth speaker DMR200 bij model RP2300FCX1J ter waarde van €



MAK PAC

RP2300FCX1J:
LIJNKOCELLAGER
CONSTANT-ELEKTRONICA
REGLBAAR TOERENTAL
MICROMETRISCHE AANSLAG

	RP0900J	RP1110CJ	RP2300FCX1J
Vermogen	900 Watt	1100 Watt	2300 Watt
Toerental	27000 t.p.m.	8000-24000 t.p.m.	9000-22000 t.p.m.
Max. induikdiepte	35 mm	57 mm	70 mm
Spantang	8 mm	8 mm	12 mm
Gewicht	2,7 kg	3,4 kg	6,1 kg
Prijs in €	Excl. BTW		
	Incl. BTW		

KANTENFREZEN



4 1977-2017 YEARS
Makita
PROFESSIONALS AT WORK

	3709	3710
Vermogen	530 Watt	530 Watt
Toerental	30000 t.p.m.	30000 t.p.m.
Spantang	6 mm	6 mm
Gewicht	1,5 kg	1,6 kg
Prijs in €	Excl. BTW	
	Incl. BTW	

COMBINATIE KANTENFREES / BOVENFREES

4 MACHINES IN 1

- Rechte kantenfrees
- Verstelbare kantenfrees
- Kantenfrees met verschoven spindel
- Bovenfrees

	RT0700CX3J
Vermogen	710 Watt
Toerental	10000-30000 t.p.m.
Max. induikdiepte	35 mm
Spantang	8 mm
Gewicht	1,8 kg
Prijs in €	Excl. BTW
	Incl. BTW

Rechte kantenfrees
Regelbare freesdiepte van 0 tot 40mm

Verstelbare kantenfrees
Hoekinstelling tussen -30° en 45°

Kantenfrees met verschoven spindel om zo dicht mogelijk tegen een obstakel te werken

Motorblok
Regelbaar toerental tussen 10.000 en 30.000 t.p.m.

Bovenfrees
Diepteregeling met een 1/16 van een mm van 0 tot 35 mm

MAK PAC

LAMELLENFREES

Revolver diepte-instelling met 6 preselecties voor een snelle afstelling.

Aanslagplaat met tandheugelverstelling voor een snelle en precieze aanpassing aan de materiaaldikte.

Kantelbare voetplaat met handig vergrendelingshendel en automatische stops op 0°, 45° en 90°.

3 JAAR GARANTIE OP MACHINES
Na registratie op www.makita.be

PJ7000J	
Vermogen	700 Watt
Toerental	11000 t.p.m.
Ø zaagblad	100 mm
Asgat	22 mm
Gewicht	2,5 kg
Prijs in €	Excl. BTW
	Incl. BTW

MULTIFUNCTIONEEL OSCILLEREND GEREEDSCHAP

INCLUSIEF:
Set van 9 accessoires en 30 schuurvellen, 1 afzuigset

GEREEDSCHAPSLOZE ACCESSOIREWISSEL

MAK PAC OIS

TM3010CX3J	
Vermogen	320 Watt
Toerental	6000-20000/min
Oscillatiehoek	3,2°
Gewicht	1,6 kg
Prijs in €	Excl. BTW
	Incl. BTW

Best. Nr.	Type	Omschrijving	Vorm	Gebruik	Prijs Excl. BTW	Prijs Incl. BTW
B-21272	TMA001	BIM-TIN segmentzaagblad multimat. Ø 85 mm		Zagen		
B-21288	TMA002	BIM-TIN segmentzaagblad multimat. Ø 65 mm				
B-21294	TMA003	BIM-TIN rondzaagblad multimat. Ø 85 mm				
B-21303	TMA004	BIM-TIN rondzaagblad multimat. Ø 65 mm				
B-21319	TMA005	BIM segmentzaagblad hout en metaal Ø 100 mm				
B-21325	TMA006	BIM segmentzaagblad hout en metaal Ø 85 mm				
B-21331	TMA007	HCS segmentzaagblad voor hout Ø 85 mm				
B-21347	TMA008	BIM invalzaagblad voor hout/nagels 40x65 mm				
B-21353	TMA009	BIM invalzaagblad hout en metaal 28x50 mm				
B-21369	TMA010	BIM invalzaagblad voor hard hout 32x40 mm				
B-21381	TMA012	HCS invalzaagblad voor zacht hout 32x40 mm				
B-21397	TMA013	HCS invalzaagblad voor zacht hout 20x30 mm				
B-21406	TMA014	HCS invalzaagblad voor zacht hout 10x30mm				
B-21412	TMA015	BIM invalzaagblad voor metaal 32x30 mm				
B-21428	TMA016	BIM invalzaagblad voor metaal 20x20 mm				
B-21434	TMA017	BIM invalzaagblad voor metaal 10x20 mm				
B-21440	TMA018	HCS afsteekmes 52x26 mm		Af-steken		
B-21456	TMA019	HCS afsteekmes 52x38 mm				
B-21462	TMA020	BIM segmentzaagblad gekarteld Ø 100 mm		Snijden		
B-21478	TMA021	HCS universele voegsnijder 28x50mm		Snijden		
B-21484	TMA022	HM-RIFF specieverwijderaar Ø 70 mm K40		Schaven, voegen, verwijderen		
B-21490	TMA023	HM-RIFF segmentzaagblad Ø 85 mm K30				
B-21509	TMA024	HM-RIFF segmentzaagblad Ø 65 mm K30				
B-21515	TMA025	HM-RIFF schuurplateau Ø 78 mm K30				
B-21521	TMA026	Diamant segmentzaagblad Ø 85 mm K40				

Best. Nr.	Type	Omschrijving	Vorm	Gebruik	Prijs Excl. BTW	Prijs Incl. BTW	
B-34805	TMA027	HM-RIFF invalzaagblad 32x30 mm		Snijden			
B-34811	TMA028	HM-RIFF invalzaagblad 20x20 mm					
B-34827	TMA029	BIM segmentmes, geschikt voor het snijden van linoleum, tapijt en rubber matten.					
B-39213	TMA030	HM invalzaagblad 40x32 mm					
B-39229	TMA031	HM invalzaagblad 30x20 mm					
B-40397	TMA035	HM invalzaagblad 65x40 mm					
B-40406	TMA036	HCS universele voegsnijder 28x50 mm			Snijden		
B-46866	TMA042	Multimes voor diverse materialen			Snijden		
B-39235	TMA032	Invalzaagblad 32			Snijden		
B-39241	TMA033	Invalzaagblad 32					
B-39257	TMA034	Invalzaagblad 32					
B-46816	TMA037	Invalzaagblad 32					
B-46822	TMA038	Invalzaagblad 32					
B-46838	TMA039	Segmentmes 32					
B-46844	TMA040	Invalzaagblad 65		Snijden			
B-46850	TMA041	Invalzaagblad 65					
B-46866	TMA042	Multimes voor diverse materialen		Snijden			
B-45478	TMA009	Invalzaagblad 28 - 5 stuks set		Zagen			
B-45484	TMA010	Invalzaagblad 32 - 5 stuks set					
B-45490	TMA012	Invalzaagblad 32 - 5 stuks set					
B-45509	TMA015	Invalzaagblad 32 - 5 stuks set					
B-45515	TMA016	Invalzaagblad 20 - 5 stuks set					
B-45521	TMA032	Invalzaagblad 32 - 5 stuks set		Snijden			
B-45537	TMA033	Invalzaagblad 32 - 5 stuks set					
B-45543	TMA034	Invalzaagblad 32 - 5 stuks set					

Hout (10 stuks)



Korrel	Best. Nr.	Prijs Excl. BTW	Prijs Incl. BTW
60	B-21624		
80	B-21630		
100	B-22947		
120	B-21646		
150	B-22953		
180	B-21652		
240	B-21668		
Assortiment			
Korrel 60, 80, 100, 240, 320 (2 stuks/K.)	B-21618		

Steen / Glas (10 stuks)



Korrel	Best. Nr.	Prijs Excl. BTW	Prijs Incl. BTW
120	B-21749		
240	B-21755		
400	B-21761		
600	B-21777		
1200	B-21783		



Verf (10 stuks)



Assortiment	Prijs Excl. BTW	Prijs Incl. BTW
Korrel 60, 80, 100, 240, 320 (2 stuks/K.)	B-21674	



Hout lange levensduur (10 stuks)



Assortiment	Prijs Excl. BTW	Prijs Incl. BTW
Korrel 60, 80, 100, 240, 320 (2 stuks/K.)	B-21559	

HANDPALM VLAKSCHUURMACHINES



BO4565K



BO4555K : VELCRO-SCHUURZOOl
BO4556K / BO4558 : BEVESTIGING SCHUURPAPIER MET KLEM
BO4565K : VELCRO-SCHUURZOOl EN INCLUSIEF DRIEHOEKSPUNT

	BO4556K	BO4555K	BO4558	BO4565K
Vermogen	200 Watt	200 Watt	200 Watt	200 Watt
Aantal schuurbewegingen	14000/min	14000/min	14000 /min.	14000/min
Schuurvoet	112x102 mm	112x102 mm	112x102 mm	112x190 mm
Gewicht	1,1 kg	1,1 kg	1,2 kg	1,2 kg
Schuurpapier bevestiging	klem	velcro	klem	velcro
Prijs in €	Excl. BTW			
	Incl. BTW			

EXCENTRISCHE VLAKSCHUURMACHINES



BO6030JX



BO5031K



BO5041K



BO6050J

	BO5031K	BO5041K	BO6030JX	BO6050J
Vermogen	300 Watt	300 Watt	310 Watt	750 Watt
Aantal schuurbewegingen	4000-12000/min	4000-12000/min	4000-10000/min	1600-6800/min
Schuurvoet	123 mm	123 mm	147 mm	147 mm
Gewicht	1,3 kg	1,4 kg	2,4 kg	2,6 kg
Prijs in €	Excl. BTW			
	Incl. BTW			

EXCENTER-POLIJSTMACHINE / SCHUUR- EN POETSMACHINES



SA7000C



PO6000C



9237CB

	SA7000C	9237CB	PO6000C
Vermogen	1600 Watt	1200 Watt	890 Watt
Toerental	0-4000 t.p.m	0-3200 t.p.m.	1600-6800 t.p.m.
Ø schijf	180 mm	180 mm	150 mm
Gewicht	3,4 kg	3,4 kg	2,7 kg
Prijs in €	Excl. BTW		
	Incl. BTW		

BORSTELSCUURMACHINE



	9741J
Vermogen	860 Watt
Toerental	3500 t.p.m.
Gewicht	4,2 kg
Prijs in €	Excl. BTW
	Incl. BTW



HANDPALM VLAKSCHUURMACHINES MET VARIABELE SNELHEID



		BO3711	BO4900VJ
Vermogen		190 Watt	330 Watt
Aantal schuurbewegingen		4000-11000/min	4000-10000/min
Schuurvoet		93x185 mm	-
Gewicht		1,6 kg	2,7 kg
Prijs in €	Excl. BTW		
	Incl. BTW		

BANDSCHUURMACHINES

9403J:
ZEER KRACHTIG,
IDEAAL VOOR INTENSIEF
SCHUURWERK



	9911J	9924DB	9903J	9031	9032	9920J	9404J	9403J
Vermogen	650 Watt	850 Watt	1010 Watt	550 Watt	500 Watt	1010 watt	1010 Watt	1200 Watt
Toerental max.	75-270 m/min	400 m/min	210-440 m/min	200-1000 m/min	300-1700 m/min	210-440 m/min	210-440 m/min	500 m/min
Schuurband	75x457 mm	75 x 610 mm	75 x 533 mm	30 x 533 mm	9 x 533 mm	75 x 610 mm	100 x 610 mm	100x610 mm
Gewicht	2,7 kg	4,8 kg	4,3 kg	2,1 kg	1,6 kg	4,5 kg	4,8 kg	5,7 kg
Prijs in €	Excl. BTW							
	Incl. BTW							

Schuurschijf 150mm
velcro multi-gebruik
(15 gaten)



Korrel	Best. Nr.	Stuks	Prijs Excl. BTW	Prijs Incl. BTW
40	B-39300	50		
60	B-39316	50		
80	B-39322	100		
100	B-39338	100		
120	B-39344	100		
240	B-39350	100		
320	B-39366	100		
360	B-39372	100		
400	B-39388	100		
500	B-39394	100		
600	B-39403	100		
800	B-39419	100		
1000	B-39425	100		

Schuurschijf 150mm
Red velcro (15 gaten)
10 stuks



Korrel	Best. Nr.	Prijs Excl. BTW	Prijs Incl. BTW
40	B-51415		
40	B-51459		
60	B-51421		
80	B-51437		
100	B-51443		
180	B-51465		
240	B-51471		
320	B-51487		
400	B-51493		

Schuurschijf 150mm
White velcro (15 gaten)
10 stuks



Korrel	Best. Nr.	Prijs Excl. BTW	Prijs Incl. BTW
40	B-51502		
60	B-51518		
80	B-51524		
100	B-51530		
120	B-51546		
180	B-51552		
240	B-51568		
320	B-51574		
400	B-51580		

WAT BETEKEN L- OF M-KLASSE?

Stofzuigers voor professioneel gebruik worden volgens EN60335-2-69 ingedeeld in risicoklassen.

L-klasse (Low risk) stofzuigers mogen gebruikt worden voor alle stof waarvan de toelaatbare blootstellings-waarde groter is dan 1 mg/m³. Deze stofzuigers laten minder dan 1% van het opgezogen stof door.

M-klasse (Medium risk) stofzuigers mogen gebruikt worden voor alle stof waarvan de toelaatbare blootstellingswaarde groter is dan 0,1 mg/m³. Deze stofzuigers laten minder dan 0,1% van het opgezogen stof door en voldoen bovendien aan een aantal bijkomende eisen, waaronder permanente debietcontrole en stofarme lediging.

Opgelet: stofzuigers zonder aanduiding van de stofklasse volgens EN60335-2-69 bieden geen enkele garantie op het vlak van persoonlijke veiligheid en zijn derhalve niet geschikt voor professioneel gebruik.

**INCLUSIEF
1 SET ACCESSOIRES**



VC2012L

STOFZUIGERS L-KLASSE

**INCLUSIEF
1 SET ACCESSOIRES**

Klasse L
VC2512L



Klasse L
VC3011L



Klasse L
VC3012L



STOFZUIGERS L-KLASSE & M-KLASSE

**INCLUSIEF
1 SET ACCESSOIRES**

Klasse L
VC2510LX1



Geruisloze zelfreinigende werking van de voorfilter door uitzetting van de schuimfilter bij uitschakelen van de stofzuiger.

Klasse L
VC3210LX1



Geruisloze zelfreinigende werking van de voorfilter door uitzetting van de schuimfilter bij uitschakelen van de stofzuiger.

Klasse M
VC3211MX1



Automatische filterreininging zonder zuigkrachtonderbreking.

Klasse H
VC3211HX1



Automatische filterreininging zonder zuigkrachtonderbreking.

STOFZUIGERS L-KLASSE & M-KLASSE

**INCLUSIEF
1 SET ACCESSOIRES**

Klasse M
VC2211MX1



Automatische filterreininging zonder zuigkrachtonderbreking.

Klasse L
VC4210LX



Automatische filterreininging zonder zuigkrachtonderbreking.



Klasse M
VC4210MX



Automatische filterreininging zonder zuigkrachtonderbreking.



	VC2512L	VC2012L	VC3011L	VC2510LX1	VC3012L
Vermogen	1100 Watt	1100 Watt	1000 Watt	1050 Watt	1200 Watt
Max. debiet	3,6 m ³ /min	3,6 m ³ /min	3,6 m ³ /min	3,5 m ³ /min	3,7 m ³ /min
Max. onderdruk	180 mbar	180 mbar	210 mbar	220 mbar	230 mbar
Bruto kuipvolume	23 l	19 l	30 l	32 l	30 l
Gewicht	6,3 kg	7,3 kg	10,5 kg	10,5 kg	10 kg
Prijs in €	Excl. BTW				
	Incl. BTW				

	VC3210LX1	VC2211MX1	VC3211MX1	VC4210LX	VC3211HX1	VC4210MX
Vermogen	1050 Watt	1050 Watt	1050 Watt	1200 Watt	1050 Watt	1200 Watt
Max. debiet	3,5 m ³ /min	3,5 m ³ /min	3,5 m ³ /min	4,5 m ³ /min	3,5 m ³ /min	4,5 m ³ /min
Max. onderdruk	220 mbar	220 mbar	220 mbar	250 mbar	220 mbar	250 mbar
Bruto kuipvolume	40 l	22 l	40 l	42 l	40 l	42 l
Gewicht	14,5 kg	16,3 kg	16,9 kg	15 kg	16,9 kg	15 kg
Prijs in €	Excl. BTW					
	Incl. BTW					

BLAAS- EN ZUIGAPPARAAT



Multifunctionele schakelaar
Variabele snelheid door de vario-schakelaar



		UB1103
Vermogen		600 Watt
Max. druk		0,057 bar
Max. debiet		0-4,1 m³/min
Gewicht		2,0 kg
Opvolger		UB1101
Prijs in €	Excl. BTW	
	Incl. BTW	

HETELUCHTPISTOLEN (MET REGELBARE TEMPERATUUR)

INCLUSIEF ACCESSOIRES



HG651CK



		HG5012K	HG551VK	HG651CK
Vermogen		1600 Watt	1800 Watt	2000 Watt
Temperatuurbereik		350-500°	100-550°	80-650°
Gewicht		0,6 kg	0,6 kg	0,6 kg
Prijs in €	Excl. BTW			
	Incl. BTW			

COMBOPACK INVALZAAG + WIPZAAG



SP6000J

4351FCTJ

		MEU029J
Duikzaag		SP6000J
Wipzaag		4351FCTJ
Geleidingsrail 1400mm		194368-5
Extra cirkelzaagblad		A-89632
Wipzaagbladjes		5
Prijs in €	Excl. BTW	
	Incl. BTW	

Geleiderail & draagtas
ter waarde van €



COMBOPACK KLOPBOORMACHINE + WIPZAAG



HP1640

4329

		DK0073J
Wipzaag		4329
Klopboormachine		HP1640
Prijs in €	Excl. BTW	
	Incl. BTW	

COMBOPACK HAAKSE SLIJERS



DK0081TJX2

Haakse slijper 125mm		GA5040R
Accu haakse slijper 125mm		DGA506RTJ
Li-ion batterij		2xBL1850
Batterijlader		DC18RC
Prijs in €	Excl. BTW	
	Incl. BTW	

COMBOPACK HAAKSE SLIJPER 125MM + STOFZUIGER + STOFAFZUIGING



STOFAFZUIGING
(196845-3)



		DK9525
Haakse slijper 125mm		9565CRX1
Stofzuiger		VC2510LX1
Prijs in €	Excl. BTW	
	Incl. BTW	

COMBOPACK SCHUURMACHINE + STOFZUIGER



DK6525

Schuurmachine		BO6050J
Stofzuiger		VC2510LX1
Prijs in €	Excl. BTW	
	Incl. BTW	

COMBOPACK KLOPBOORMACHINE + HAAKSE SLIJPER



DK0050X1

Klopboormachine 710 W		HP1631
Haakse slijper 125mm		GA5030R
Borensset		D-08660
Synthetische koffer		✓
Opvolger van		DK1139
Prijs in €	Excl. BTW	
	Incl. BTW	

GENERATOREN MET AVR-REGELING



	EG2250A	EG2850A	EG4550A	EG5550A	EG6050A
Motortype	OHV	OHV	OHV	OHV	OHV
Cilinderinhoud	210 cc	210 cc	420 cc	420 cc	420 cc
Vermogen	2,2 kW	2,8 kW	4,5 kW	5,5 kW	6,0 kW
Spanningsregeling	AVR	AVR	AVR	AVR	AVR
Gewicht	49,8 kg	52,8 kg	95,5 kg	98,5 kg	100,5 kg
Prijs in €	Excl. BTW				
	Incl. BTW				

COMPRESSORS



transportwagen
ter waarde van
€ bij AC310H

	AC640	AC1300	AC310H
Vermogen	1460 Watt	2100 Watt	1800 Watt
Max. druk	8 bar	10 bar	25,3 bar
Max. debiet	170 l/min	240 l/min	90 l/min
Inhoud persluchtank	6 L	20 L	6,2 L
Gewicht	15 kg	31 kg	36 kg
Prijs in €	Excl. BTW		
	Incl. BTW		

PNEUMATISCH
CONSTRUCTIENAGELPISTOOL



AN943K

Max. druk	8,5 bar	
Ø Nagelkop	7,0 mm	
Doorsnede nagel	2,9-3,3 mm	
Lengte nagel	50-90 mm	
Gewicht	3,9 kg	
Prijs in €	Excl. BTW	
	Incl. BTW	

PNEUMATISCH NIETPISTOOL



AT638

Max. druk	8 bar	
Draadkaliber	18 Ga	
Doorsnede niet	1,1x1,3 mm	
Rugbreedte niet	5 mm	
Lengte niet	15-38 mm	
Gewicht	1,5 kg	
Prijs in €	Excl. BTW	
	Incl. BTW	

MINIBRADPISTOOL



AF505N

Max. druk	8 bar	
Draadkaliber	18 Ga	
Ø Nagelkop	2,0 mm	
Doorsnede nagel	1,2 mm	
Lengte nagel	15-50 mm	
Gewicht	1,4 kg	
Prijs in €	Excl. BTW	
	Incl. BTW	

GASNAGELPISTOOL
VOOR AFWERKNAGELS



GF600SE

Batterijcapaciteit	7,2 V / 1,0 Ah	
Gemiddelde oplaadtijd	30 min.	
Doorsnede nagel	1,6 mm	
Lengte nagel	15-64 mm	
Gewicht	2,2 kg	
Prijs in €	Excl. BTW	
	Incl. BTW	

GASNAGELPISTOOL VOOR BETON



GN420CSE

Batterijcapaciteit	7,2 V / 1,0 Ah	
Gemiddelde oplaadtijd	30 min.	
Doorsnede nagel	2,6-3,0 mm	
Lengte nagel	15-40 mm	
Gewicht	3,5 kg	
Prijs in €	Excl. BTW	
	Incl. BTW	

GASNAGELPISTOOL VOOR HOUT



GASPISTROON



Best. Nr.	242094-1
Prijs (Excl. BTW)	
Prijs (Incl. BTW)	

GN900SE

Batterijcapaciteit	7,2 V / 1,0 Ah	
Gemiddelde oplaadtijd	30 min.	
Doorsnede nagel	2,9 - 3,3 mm	
Lengte nagel	50-90 mm	
Gewicht	3,3 kg	
Prijs in €	Excl. BTW	
	Incl. BTW	



LASER-AFSTANDSMETER



LD030P



LD080PI



		LD030P	LD050P	LD080PI
Bereik		30 m	50m	80m
Gewicht		0,1 kg	0,1 kg	0,1 kg
Prijs in €	Excl. BTW			
	Incl. BTW			

KRUISLIJN LASERS



statief 1,5 m
ter waarde
van €



SK103PZ



SK104Z

inclusief
eenvoudige
wandhouder,
magnetische
richteenheid



		SK104Z	SK103PZ
Bereik		15 m	15 m
Gewicht		0,47 kg	0,37 kg
Opvolger van		SK102Z	-
Prijs in €	Excl. BTW		
	Incl. BTW		

SK103PZ: laserhoek tot 180°
Pulse/power functie :Versterkte
lichtintensiteit verhoogde
zichtbaarheid in daglicht.

ROTERENDE LASER



statief 2,7 m
ter waarde
van €



Inclusief statief,
magnetische richtplaat
bril voor laser,
afstandsbediening

		SKR200Z
Rotatiesnelheid		0-600 t.p.m.
Bereik		100 m
Gewicht		1,6 kg
Prijs in €	Excl. BTW	
	Incl. BTW	

LIJNLASERS



SK209GDZ



SK312GDZ



SK209GDZ

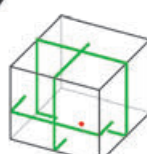

SK312GDZ

+ Powerpack
197657-7



NIEUW

		SK209GDZ	SK312GDZ
Nauwkeurigheid		+1 mm / 10 m	+1 mm / 10 m
Aantal lijnen		3 x groen	3 x groen
Aantal accu's		+ powerpack 10,8V	+ powerpack 10,8V
Gewicht		1,6 kg	1,5 kg
Prijs in €	Excl. BTW		
	Incl. BTW		

DUC252Z / DUC302Z

SNOEIKETTINGZAGEN

18v + 18v → 36v



DUC252Z

DUC302Z



DUC353Z

SNOEIKETTINGZAAG

BL
MOTOR



DUC353Z

18v + 18v → 36v

XPT
EXTREME PROTECTION TECHNOLOGY



DUH551Z / DUH651Z

ACCU HEGGENSCHAREN



18v + 18v → 36v



DUH651Z

DUH551Z

XPT
EXTREME PROTECTION TECHNOLOGY

DLM380Z / DLM431Z

ACCU GRASMAAIERS



DLM380Z

DLM431Z

18v + 18v → 36v

POWER PACK 18V 5.0Ah

197629-2



POWER PACK 18V 5.0Ah

197626-8



18v + 18v → 36v

DCU180Z
ACCU KRUIWAGEN

NIEUW
leverbaar
vanaf december

+ kuip



Uitgerust met
LED verlichting (2x)

OPTIONEEL TOEBEHOREN

Buizenframe	199009-8
-------------	----------

DUB362Z
ACCU BLADBLAZER

+ Platte
blaasmond

BL
MOTOR

Go Green



18v + 18v → 36v

XPT
EXTREME PROTECTION TECHNOLOGY

DUR364LZ / DUR365UZ
ACCU BOSMAAIERS

Go Green



18v + 18v → 36v

BL
MOTOR

XPT
EXTREME PROTECTION TECHNOLOGY

DLX2231PTJ
ACCU COMBOPACK TUIN

Go Green



DLX2231PTJ	
Oplaadtijd	45 min
Grastrimmer	DUR181
Grasmaaier	DLM431
Powerpack 18V 5.0Ah	197629-2

DLXOPE2X18V
ACCU COMBOPACK TUIN 18V

18v + 18v → 36v



Go Green

DLXOPE2X18V	
Li-ion 18V	4 x accu 5,0 Ah
Oplaadtijd	45 min
Heggenschaar	DUH651
Bladblazer	DUB362
Kettingzaag	DUC252
Bosmaaier	DUR365U
Grasmaaier	DLM431

ACCU COMBOPACK TUIN

ACCU COMBOPACK TUIN



DLX2114X1	
Li-ion 18V	2x accu 3,0 Ah
Oplaadtijd	22 min
Accu klopboor- en schroefmachine	DHP453Z
Accu grastrimmer	DUR181Z
Veiligheidsbril	769014-5
Snellader	DC18RC

DLX3018X1	
Li-ion 18V	2x accu 3,0 Ah
Oplaadtijd	22 min
Accu heggenschaar	DUH523Z
Accu grasschaar	DUM168Z
Accu grastrimmer	DUR181Z
Snellader	DC18RC

ACCU COMBOPACK TUIN

ACCU COMBOPACK TUIN



DLX2113X1	
Li-ion 18V	2x accu 3,0 Ah
Oplaadtijd	22 min
Accu heggenschaar	DUH523Z
Accu klopboor- en schroefmachine	DHP453Z
Snellader	DC18RC



DLXOPE1X18V	
Li-ion 18V	2x accu 3,0 Ah
Oplaadtijd	22 min
Boorschroefmachine	DHP453RFX2
Grastrimmer	DUR181
Snellader	DC18RC



ELEKTRISCHE KETTINGZAAG SEMI-PRO

1800 Watt



koffer & accessoires

UC3541AK	
Vermogen	1800 Watt
Zaaglengthe	35 cm
Gereedschapsloos snelspansysteem	✓
Gewicht	20 - 55 mm
Koffer	✓



ELEKTRISCHE KETTINGZAGEN PRO

2000 Watt



Handbijl

koffer & accessoires bij UC3551AK & UC4051AK

	UC3051A	UC3551AK	UC4051AK	UC4551A
Vermogen	2000 Watt			
Zaaglengthe	30 cm	35 cm	40 cm	45 cm
Gereedschapsloos snelspansysteem			✓	
Gewicht	5,4 kg	5,5 kg	5,6 kg	5,7 kg
Koffer	-	✓	✓	-

MOTORKETTINGZAGEN 1,35 kW / 1,7 kW



Gereedschapsloos snelspansysteem
EA3201S35X



	EA3200S35X	EA3201S35X	EA3500S35B	EA3600F35B
2-takt			✓	
Cilinderinhoud		32 cc	35 cc	35,2 cc
Vermogen		1,85 pk / 1,35 kW	2,3 pk / 1,7 kW	2,4 pk / 1,7 kW
Zaaglgte		35 cm		
Gereedschapsloos snelspansysteem	-	✓	-	-
Gewicht	4,1 kg	4,2 kg	4,4 kg	4,8 kg

BENZINE KETTINGZAGEN 2,2 kW / 2,4 kW / 2,8 kW



Handbijl bij
modellen
EA4300

koffer &
accessoires
bij KIT
versies



	EA4300F38C	EA4300F45C-KIT	DCS5121-45-KIT	EA5000P45E-KIT
2-takt			✓	
Cilinderinhoud		42,4 cc	49,9 cc	50 cc
Vermogen		3,0 pk / 2,2 kW	3,3 pk / 2,4 kW	3,8 pk / 2,8 kW
Zaaglgte	38 cm		45 cm	
Gewicht		4,8 kg	5,6 kg	5,1 kg

BENZINE KETTINGZAAG 4,9 KW



DCS9010-60	
2-takt	✓
Cilinderinhoud	90 cc
Vermogen	6,7 pk / 4,9 kW
Zaaglengthe	74 cm
Gewicht	8,2 kg

BENZINE SNOEIKETTINGZAGEN



Mag uitsluitend worden bediend door opgeleide boomverzorgers.



EA3110T30B	
2-takt	✓
Cilinderinhoud	30,1 cc
Vermogen	1,4 pk / 1,0 kW
Zaaglengthe	30 cm
Gewicht	3,2 kg

TELESCOPISCHE STOKKETTINGZAAG

Uitschuifbaar tot 390 cm

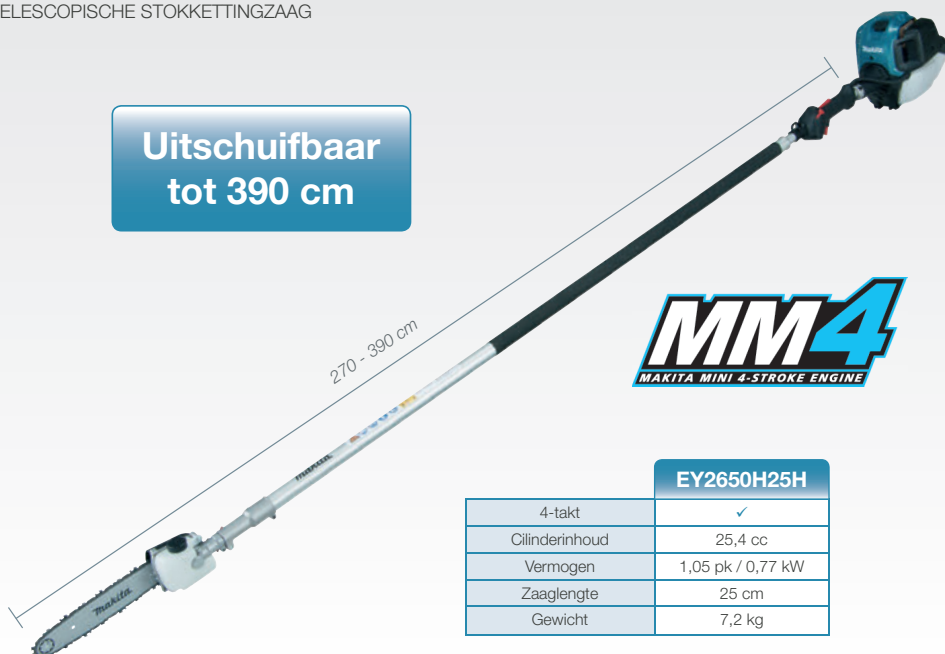

MM4
MAKITA MINI 4-STROKE ENGINE

EY2650H25H	
4-takt	✓
Cilinderinhoud	25,4 cc
Vermogen	1,05 pk / 0,77 kW
Zaaglengthe	25 cm
Gewicht	7,2 kg





GRASTRIMMER

MM4
MAKITA MINI 4-STROKE ENGINE

Go Green



	ER2650LH
4-takt	✓
Cilinderinhoud	25,4 cc
Vermogen	1,05 pk / 0,77 kW
Handgreepvorm	D
Gewicht	4,8 kg

MOTOR COMBI-SYSTEEM

MM4
MAKITA MINI 4-STROKE ENGINE

Go Green



	EX2650LH
4-takt	✓
Cilinderinhoud	25,4 cc
Vermogen	1,05 pk / 0,77 kW
Handgreepvorm	D
Gewicht	4,6 kg

MOTOR COMBI-SYSTEEM MET BOSMAAIER OPZETSTUK

EM400MP
Ø 42 cm

Go Green

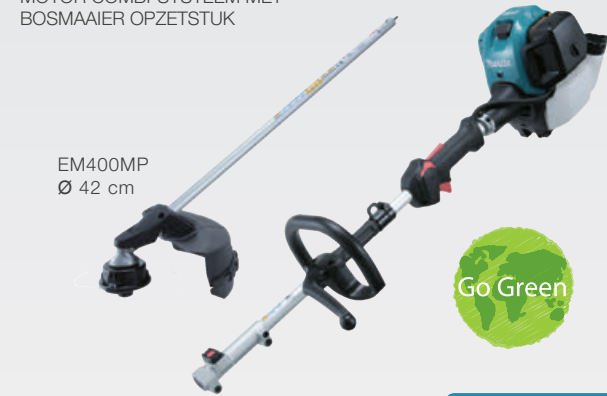

MM4
MAKITA MINI 4-STROKE ENGINE

	EX2650LHM1
4-takt	✓
Cilinderinhoud	25,4 cc
Vermogen	1,05 pk / 0,77 kW
Handgreepvorm	D
Gewicht	6,2 kg

OPZETSTUKKEN

Bosmaaier opzetstuk	Grastrimmer opzetstuk	Snoeikettingzaag opzetstuk	Stokheggenschaar opzetstuk	Cultivator opzetstuk	Boordensnijder opzetstuk	Verlengstuk opzetstuk
EM400MP 195648-2 EM401MP 195888-2	ER400MP 195522-4	EY401MP 196101-1	EN401MP 196256-2	KR400MP 195707-2	EE400MP 196752-0	LE400MP 196032-4
EM400MP € 81,82 excl. BTW € 99,00 incl. BTW EM401MP € 90,08 excl. BTW € 109,00 incl. BTW	€ 81,82 excl. BTW € 99,00 incl. BTW	€ 230,58 excl. BTW € 279,00 incl. BTW	€ 230,58 excl. BTW € 279,00 incl. BTW	€ 222,32 excl. BTW € 269,00 incl. BTW	€ 106,62 excl. BTW € 129,00 incl. BTW	€ 81,82 excl. BTW € 99,00 incl. BTW

ACCU GRAS- EN HEGGENSCHAREN



CXT



	UH201DZ	UM600DSAEX
Li-ion	10,8V	10,8V / 2,0Ah
Snijlengte	20 cm	26 cm
Maximale takdikte	8 mm	
Gewicht	1,3 kg	1,2 kg



ACCU GRAS-EN HEGGENSCHAAR



18V
LITHIUM-ION

	DUM168RFEX	DUM168ZX
Li-ion 18V	2 x accu 3,0 ah	-
Snijbreedte	16 cm	
Oplaadtijd	22 min.	
Gewicht	1,6 kg	





Betrouwbare en milieuvriendelijke Makita 4-takt motoren

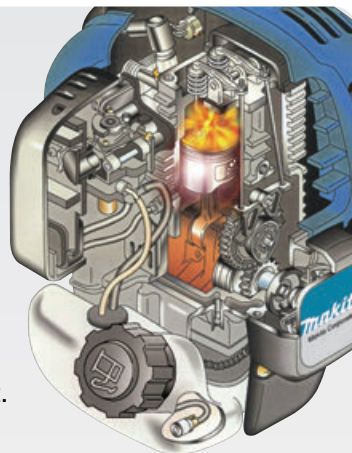

De 4-takt motoren van Makita bieden volgende voordelen: **Uitstekende prestaties, compact en licht in gewicht, een lage uitstoot, lage gebruikskosten, eenvoudig in onderhoud en ze zijn stil**, zeker in vergelijking met een 2-takt motor van hetzelfde formaat.

Makita 4-takt motoren hebben hoge koppel- en pk-waarden. De maximale koppel- en pk-waarden van een Makita 4-takt motor zijn vrijwel gelijk aan die van een gelijkwaardige 2-takt motor.

BENZINE STOKHEGGENSCHAREN

	EN4950H	EN4951SH
4-taktmotor		✓
Cilinderinhoud		25,4 cc
Vermogen		1,1 pk / 0,77 kW
Snijlengte		49 cm
Totale lengte	255 cm	205 cm
Gewicht	7,2 kg	6,6 kg



BLADBLAZER / ZUIGER



Geleverd met bladzuigset

	UB0801V
Vermogen	1650 Watt
Luchtsnelheid	83 m/sec
Maximum debiet	7,1 m³/min
Gewicht	3,8 kg



ACCU BLADBLAZER LXT

18v + 18v → 36v



**BL
MOTOR**



DUB362Z	
Batterijcapaciteit	2 x 18V
Maximum debiet	13,4 m³/min
Luchtsnelheid	54 m/sec
Gewicht	3,5 kg



BLADBLAZERS / ZUIGER

BHX2501V geleverd met bladzuigset



MM4
MAKITA MINI 4-STROKE ENGINE



	BHX2501X1	BHX2501V	EB7660TH
4-takt		✓	
Cilinderinhoud		24,5 cc	75,6 cc
Vermogen		1,1 pk / 0,81 kW	4,1 pk / 3,0 kW
Luchtsnelheid		65 m/sec	92 m/sec
Gewicht		6 kg	10,9 kg

TUINMACHINES

WATERPOMPEN



EW1060HX



	EW1050HX	EW1060HX
4-takt		✓
Cilinderinhoud	24,5 cc	33,5 cc
Vermogen	1,0 pk / 0,71 kW	1,5 pk / 1,07 kW
Max. aanzuighoogte	8 m	
Debiet	110 l/min.	130 l/min.
Gewicht	5,8 kg	7,3 kg

SEMI - VUILWATERPOMPEN

EW3051H



	EW2051H	EW3051H
4-takt		✓
Cilinderinhoud	169 cc	
Inhoud brandstoftank	3,2 l	
Debiet	700 l/min.	1000 l/min.
Gewicht	24,9 kg	26,1 kg

WATERPOMPEN

EW3050H



	EW2050H	EW3050H
4-takt		✓
Cilinderinhoud	169 cc	
Inhoud brandstoftank	3,2 l	
Debiet	520 l/min.	1000 l/min.
Gewicht	24,9 kg	26,1 kg

DOMPELPOMPEN



PF0800



PF1010



PF1100



PF1110

	PF0800	PF1010	PF1100	PF1110
Vermogen	800 Watt		1100 Watt	
Max. toevoercapaciteit	140 l/min.	240 l/min.	250 l/min.	
Max. opvoerhoogte	9 m	10 m	9 m	10 m
Gewicht	6,1 kg	6,6 kg	6,7 kg	7,0 kg

BLADBLAZER / VERNEVELAAR



	PM7651H
4-takt	✓
Cilinderinhoud	75,6 cc
Vermogen	3,7 pk / 2,7 kW
Luchtsnelheid	85 m/sec
Gewicht	14,1 kg



HOGEDRUKREINIGERS



HW111



HW132



HW131



HW151

	HW111	HW132	HW131	HW151
Vermogen	1700 Watt	2100 Watt	2200 Watt	2500 Watt
Druk	110 bar	140 bar	130 bar	150 bar
Debiet	370 l/u	420 l/u	500 l/u	
Haspel	5,5 m	8 m	15 m	10 m
Gewicht	7,4 kg	18,8 kg	33 kg	26,9 kg



STANDAARD TOEBEHOREN		HW111	HW132	HW131	HW151
Verlengstuk voor spuitmondgreep		✓ 3320130			
Spuitmond voor reinigingsmousse		✓ 3640670	✓ 3640670		
Lans met regelbare spuitmond		✓ 3640650	✓ 3640930	✓ P-64901	✓ 40551
Lans met turbo spuitmond (rotopower)		✓ 3320120	✓ 3640940	✓ P-64917	✓ 40167
Rechte borstel		✓ 3640950	✓ 3640950		
Koppelstuk				✓ P-64870	
Spuitmondgreep		✓ 3320152	✓ 3640920	✓ P-72431	✓ 41154



HOGEDRUKREINIGERS



HW1200



HW1300



	HW1200	HW1300
Vermogen	1600 Watt	1800 Watt
Druk	120 bar	130 bar
Debiet	420 l/u	420 l/u
Haspel	5 m	5 m
Gewicht	9,7 kg	10,3 kg

RUGGEDRAGEN SPROEIER



Go Green





	EVH2000
4-takt	✓
Cilinderinhoud	24,5 cc
Druk	25 bar
Debiet	7,1 l/min
Inhoud sproeistoftank	20 l
Gewicht	9,1 kg

MM4
MAKITA MINI 4-STROKE ENGINE

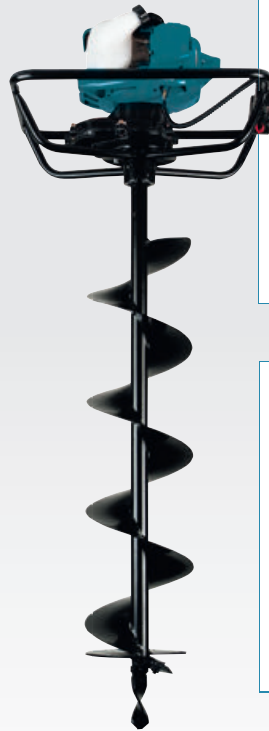
GRONDBOOR



Grondboren	Best. Nr.	Ø (mm)	Lengte (mm)
	P-49155	80	800
	P-49161	100	800
	P-49177	120	800
	P-49183	150	800
	P-49199	180	800
	P-49208	200	800

Vervangmessen	Best. Nr.	Kenmerk gereedschap (Ø mm)
	BB600470	80
	BB600150	100
	BB600450	120
	BB600170	150
	BB600460	180
	BB600180	200

Verlengstukken

Best. Nr.	Lengte (mm)
P-49214	800

BBA520

2-taktmotor	✓
Vermogen	2,66 pk / 1,98 kW
Spindeltoerental max.	160-200 min-1
Max. grondboordiameter	22 cm
Opvoerpomp	✓
Gewicht	10,5 kg

ELEKTRISCHE VERTICUTEERDERS



UV3200



UV3600



	UV3200	UV3600
Vermogen	1300 Watt	1800 Watt
Breedte	32 cm	36 cm
Polypropyleen chassis	✓	
Gewicht	15 kg	18,3 kg

Makita
PROFESSIONALS AT WORK

n.v. Makita s.a.
Jan-Baptist Vinkstraat 2 • B-3070 Kortenberg
Tel. (02) 257 18 40 • Fax (02) 253 01 01
e-mail: csd@makita.be • www.makita.be

MIX
Papier van
verantwoorde herkomst
FSC® C003224