

# HIKOKI

HIGH PERFORMANCE POWER TOOLS

Power Tools  
catalogus

2018-2019



# Innovation never stops

Sinds 1948 houden wij ons bezig met het ontwerpen en produceren van high performance power tools. Al 70 jaar gebruiken onze Japanse engineers hun technologische kennis, vaardigheden en ervaringen om onze power tools constant te verbeteren. Japanse designprincipes leiden ertoe dat ieder element van onze producten wordt gekozen om de prestatie, de balans, het gebruik, de levensduur en de controle te verbeteren. Aandacht voor detail die ervoor zorgt dat de professional alle werkzaamheden zo makkelijk mogelijk kan afronden. Dat is wat ons motiveert en waardoor we voortdurend voorop blijven lopen.

**HIKOKI**  
HIGH PERFORMANCE POWER TOOLS

Met trots introduceren we onze 2018-2019 catalogus. Bekijk alle HiKOKI high performance power tools van dit jaar. Allemaal gebundeld in een overzichtelijk boek. Bekende modellen maar ook nieuwe voorzien van het nieuwste design en de laatste technologieën waar onze in-house designers en engineers aan hebben gewerkt.



# Contents.

## Everything to reach the highest performance.

## Innovation never stops

## Contents

## General information

## Index

## Technologies

## Our flagships

## Accu machines

Accu machines	36 V	21
Accu machines	18 V	24
Lampen	18 V	36
Ventilator	18 V	36
Radio's	18 V	37
Combo packs		38
Accu machines	10,8 V	41
Accu machines	3,6 V	43
MULTI VOLT accu's en laders		45
Li-ion accu's en laders		46
Ni-MH accu's en laders		48
Ni-CAD accu's en laders		48

## Klop-boor-schroefmachines

Boormachines		50
Boor-schroefmachines		51
Klop-boor-schroefmachines		53
Haakse boormachine		56
Schroevendraaiers		56
Schroefautomaat		58

## Slagmoeraanzetters

Slagmoeraanzetters		60
--------------------	--	----

## Mixers

Mixers		63
--------	--	----

## Hamers

Boorhamers	65
Boor-hakhamers	66
Hakhamers	70

## Slijpmachines

Haakse slijpmachines	75
Diamant slijpmachines	81
Haakse doorslijpmachine	82
Rechte slijpmachines	82
Haakse schuur- en polijstmachines	83
Excentrische haakse schuurmachine	83
Knabbelschaar	84
Platenschaar	84

## Zaagmachines

Cirkelzaagmachines	86
Decoupeerzaagmachines	88
Reciprozaagmachines	90
Multi tool	90
Afkortzaagmachines	91
Zaagstandaards	95
Doorslijpmachine	95

## Schaaf- en freesmachines

Schaafmachines	97
Bovenfreesmachines	97

## Schuurmachines

Bandschuurmachines	100
Vlakschuurmachines	100
Excenter schuurmachines	102

## Stofzuigers

Nat- en droogstofzuigers	104
Blaas-zuigapparaat	106

## Overig

Compressor	108
Heteluchtpistolen	108
Motorslijpmachines	109
Hogedrukreinigers	109

## HiKOKI System Case

HiKOKI System Case	112
--------------------	-----

## Stofafzuiging

Stofafzuiging	115
---------------	-----

**General  
information.  
Good to know  
before reading.**

## Kwaliteitscontrole en garantie

Ervaren keurmeesters die uiterst streng controleren voor, tijdens en na de productie. Een streng geborgd kwaliteitscontroleprogramma waarbij zelfs tijdens de opslag steekproefsgewijs het behoud van die hoge kwaliteit wordt gegarandeerd. Elke HiKOKI dient daardoor de eindgebruiker in onberispelijke staat te bereiken. Mochten er desondanks fouten of storingen optreden die niet zijn veroorzaakt door foutief gebruik, onachtzaamheid of normale slijtage, dan zullen deze onvolkomenheden kosteloos door HiKOKI Power Tools worden hersteld na overleg van een geldig en juist ingevuld garantiebewijs waaruit blijkt dat de machine niet ouder is dan 1 jaar. Voor machines die worden gehuurd geldt in principe geen garantie. Indien door de gebruiker de machine wordt gedemonteerd vervalt elk recht op garantie.

## Reparatie

Gereedschap heeft onderhoud nodig, slijtdelen moeten af en toe worden vervangen en hoe goed er ook is nagedacht over de duurzaamheid: de beste machine gaat ook nog wel eens stuk. HiKOKI Power Tools waardeert jouw keuze voor ons kwaliteitsgereedschap, dus als er onderhoud of reparatie nodig blijkt, dan laten wij je graag zien dat je ook qua service een juiste fabrikant heeft gekozen. HiKOKI biedt je namelijk: Power Service, een zeer compleet service-concept, waarin 3 belangrijke aspecten centraal staan: vakkundigheid, duidelijkheid en snelheid.

## Vakkundigheid

HiKOKI Power Tools beschikt zelf over een modern geoutilleerde en vakbekwaam bemande eigen technische dienst.

## Duidelijkheid

Je kent het wel, uitgerekend als het je het minst uitkomt, is er iets mis met jouw machine. Het enige waar je dan eigenlijk in geïnteresseerd bent is: 'wat kost de reparatie?' en 'wanneer kan ik weer aan de slag?'.

Die vragen beantwoordt jouw HiKOKI dealer meteen op het moment dat je de machine ter reparatie aanbiedt. Je weet dus direct waar je aan toe bent. Je kunt zelfs aangeven wat de reparatie je maximaal zou mogen kosten. En mochten die kosten je tegenvallen, of is het zelfs niet eens meer reëel om de machine te repareren, dan heeft de HiKOKI dealer meteen een bijzonder aanbod voor je: het innemen van de ongerepareerde machine levert jou een inruilbonus op, die je kunt verzilveren bij aanschaf van een nieuwe vergelijkbare HiKOKI machine. Zo kan je dus meteen verder aan het werk! Duidelijkheid komt ook tot uiting in het HiKOKI reparatiedocument, dat samen met jou aan de balie wordt ingevuld. Het formulier voorziet in een optimale registratie van niet alleen jouw wensen, maar ook welke accessoires er meegezonden worden. Dat houdt het duidelijk voorkomt misverstanden.

## Snelheid

De informatie die je meteen bij het aanbieden van de reparatie wordt verschaft, draagt natuurlijk al erg veel bij aan de snelheid. Immers, veel communicatie over en weer is nu uitgesloten. Ook als je besluit de reparatie te laten uitvoeren, houden HiKOKI en haar dealers de vaart er voor jou in. Via een uitgekiend logistiek traject wordt de machine razendsnel gerepareerd en desgewenst, onderworpen aan een NEN3140 keuring. Als regel hoeft je de machine niet langer dan 3 werkdagen te missen.

## Veiligheid

HiKOKI gereedschappen zijn voor de Europese markt ontwikkeld en voldoen aan alle landelijk geldende veiligheidsvoorschriften. De in de catalogus opgenomen, niet snoerloze machines en opladers, zijn geschikt voor 220 V - 230 V wisselstroom. Indien de machines gebruikt, aangepast of uitgebreid worden in strijd met de originele specificaties of instructies en zonder voorafgaande schriftelijke toestemming, is HiKOKI Power Tools niet aansprakelijk voor enige schade die daaruit voortvloeit.

## CEE-publicatie 20

Veiligheidsisomatie volgens DIN57740/VDE00740. Radio-ontstoring volgens PTT-voorschrift 0875.

## Gewicht

Het gewicht van nieuwe producten is volgens de EPTA-Procedure 01/2003.



## EC verklaring van conformiteit

HiKOKI Power Tools verklaart onder eigen verantwoordelijkheid dat de in deze catalogus opgenomen machines conform de richtlijnen of gestandaardiseerde documenten EN60745-1, EN60745-2-1, EN55014-1, EN61000-3-2 en EN61000-3-3 voldoen aan de bepalingen 2004/108/EC en 2006/42/EC.

De producten voldoen aan de RoHS-richtlijnen 2011/65/EU en van toepassing op producten voorzien van de CE markering.

1. Serienummer: aangegeven op de merkplaat
2. Bouwjaar: gecodeerd in serienummer

## Verklaring der tekens

	Dubbel geïsoleerd		Batterijen recycleren
	Constante snelheid		Elektrische rem
	Aanloopstroombegrenzing		SDS-Max
	Variabele snelheid		SDS-Plus
	Regel-electronic (feed back)		1/2" vierkant
	Pendelbeweging		3/4" vierkant
	Trillingabsorberende handvatten		1/4" zeskant
	Rechts en links draaiend		28 mm zeskant
	Geïntegreerde stofafzuiging		30 mm zeskant
	Spindelblokkering		EC verklaring van conformiteit
	Veiligheidsslipkoppeling		

## Accu capaciteit



# Index

## 3

318368	48
319105	48
319765	48
322878	48
326299	46
327731	46
327729	46
328033	46
328036	46
330557	46
330558	46
331067	46
333156	48
333159	48
333161	48
334998	46
335684	46
335784	46
335786	46
335788	46
335790	46
336472	112
336473	112
336474	112
336475	113
337109	112
337110	112
337111	112
337112	112
337113	112
337114	112
337288	112
337529	112
337658	112
337659	112
337740	112
337741	112
337742	112
337743	112
337746	112
337763	112
337764	112
337937	112
337941	113
338887	46
338891	46
339780	46
339783	46
339973	46
339975	46

370330	112
371750	45
373788	45

## 4

402538	113
402539	113
402540	113
402541	113
402542	112
402543	113
402544	112
402545	112
402546	112
402547	112

## 7

711240	112
711241	112
711242	112
711243	112
712650	95
714959	24
715699	113
750409	115
783102	115
783104	115
783106	115
783107	115
783109	115
783113	115
783114	115
783115	115
783116	115
783120	115
783121	115
783122	115
783123	115

## A

AW100LAZ	110
AW130LAZ	110
AW150LAZ	109

## C

C10FCH2LA	93
C10FCH2WAS	93
C10FSHUBZ	92
C10FSHWASZ	92

C12LCHUTZ	93
C12LCHUTWZ	94
C12LSHWA	94
C12LSHWAS	94
C18DBALW2Z	30
C18DBALW4Z	30
C18DBALWPZ	30
C3606DAW2Z	24
C3606DAWRZ	24
C6U3W1Z	88
C7BUMW1Z	87
C7MFALAZ	87
C7SSUTZ	88
C7U3W1Z	87
C7UYLXZ	86
C8FSEUAWZ	92
C8FSEUAZ	91
C8FSHEUAWZ	91
C8FSHEUAZ	91
C9BU3WBZ	86
C9U3WBZ	86
CB18DBLW4SZ	33
CB18DBLW4Z	33
CB18DBLWJZ	33
CC14SFWAZ	95
CE16SAUAZ	84
CE18DSLW4SZ	34
CE18DSLW4Z	34
CE18DSLWPZ	34
CJ160VAW1Z	89
CJ160VW1Z	88
CJ18DSL2Z	32
CJ18DSLW4Z	32
CJ18DSLWPZ	32
CJ90VASTWAZ	89
CJ90VSTWAZ	89
CL18DSL6SZ	32
CL18DSL6Z	32
CL18DSL6Z	32
CL18DSL6Z	32
CL18DSL6Z	32
CM12YUAZ	82
CM5SBU1Z	81
CM75EAPWAZ	109
CM75EBPWAZ	109
CM9SRWSZ	82
CM9UBYWSZ	81
CN16SAUAZ	84
CN18DSLW4SZ	34
CN18DSLW4Z	34
CN18DSLWPZ	34
CR10DLWCZ	43
CR13V2WSZ	90
CR13VBYWSZ	90
CR18DBLW4SZ	32

CR18DBLW4Z	32
CR18DBLWJZ	32
CV18DBLW2Z	33
CV18DBLW4Z	33
CV18DBLWPZ	33
CV350VW1Z	90

## D

D10VC3WCZ	52
D10VFWUZ	51
D10VGWUZ	50
D10YBM1Z	56
D13VB3LBZ	52
D13VFWUZ	50
D13VGWUZ	50
D13VLWDZ	51
D13WAZ	52
D6SHUAZ	51
DB3DL2WCZ	43
DH18DBLW2DZ	28
DH18DBLWPDZ	28
DH18DBLW2Z	29
DH18DBLW4Z	29
DH18DBLWPZ	29
DH24PGWSZ	66
DH24PHWSZ	68
DH26PBW1Z	65
DH26PBWSZ	65
DH26PCW1Z	68
DH26PCWSZ	68
DH28PBYWSZ	65
DH28PCWSZ	67
DH28PCYWSZ	67
DH28PDWSZ	66
DH28PMYWSZ	67
DH30PC2WSZ	66
DH36DPAW2DZ	22
DH36DPAWRDZ	22
DH36DPAW2Z	21
DH36DPAWRZ	21
DH40MCWSZ	70
DH40MEYWSZ	69
DH45MEYWSZ	69
DH52MEYWSZ	69
DM20VWVZ	53
DN18DSL2Z	28
DN18DSL4Z	28
DN18DSLLEZ	28
DS10DALWCZ	41
DS10DALWPZ	41
DS18DBL2W2Z	24
DS18DBL2W4Z	24

DS18DBL2WPZ	24
DS18DBSLW3Z	25
DS18DBSLW6Z	25
DS18DBSLWFZ	25
DS18DBSLWNZ	25
DS18DJLWCZ	26
DS18DJLWLZ	26
DS18DJLWQZ	26
DS18DSDLL2Z	25
DS18DSDLW4Z	25
DS18DSDLWPZ	25
DS36DAW2Z	21
DS36DAWRZ	21
DV18DBL2W2Z	27
DV18DBL2W4Z	27
DV18DBL2WPZ	27
DV18DBSLW3Z	27
DV18DBSLW6Z	27
DV18DBSLWPZ	27
DV18DSDLW4SZ	28
DV18DSDLW4Z	28
DV18DSDLWPZ	28
DV16VWUZ	55
DV18VWUZ	55
DV20VB2WSZ	54
DV20VB2WUZ	54
DV20VB2WVZ	54
DV20VDW4Z	53
DV22VW4Z	53
DV36DAW2Z	21
DV36DAWRZ	21

## E

EC58LAZ	108
---------	-----

## F

FDV16VB2U3Z	55
FSV10SALAZ	101

## G

G13BAWQZ	76
G13BYWQZ	75
G13SB3SDZ	81
G13SB3YZZ	76
G13SE2YHZ	77
G13SE2YZZ	76
G13SR4YGZ	77
G13SWYIMZ	77
G13VAWKZ	75
G13VEWQZ	75



G13YC2LAZ	76	KC18DRBLWBDZ	39	SV12SHWBZ	101	WR16SEWAZ	60
G13YGWQZ	75	KC18DRBLWDZ	39	SV13YAWBZ	102	WR18DBDL2W2Z	29
G18DBBALW2Z	31			SV13YBWBZ	102	WR18DBDL2W4Z	29
G18DBBALW5Z	31			SV15YCWBZ	102	WR18DBDL2WPZ	29
G18DBBALWQZ	31					WR18DSHLL2Z	29
G18DBBLW2Z	31	<b>M</b>		<b>U</b>		WR18DSDLW4Z	29
G18DBBLW5Z	31	M12V2LAZ	97	UB18DALE0Z	36	WR18DSDLWPZ	29
G18DBBLWQZ	31	M12VEUTZ	98	UB18DELL0Z	36	WR22SEWAZ	60
G18DBBVLW2Z	31	M8SA2LAZ	98	UB18DGLL0Z	36	WR25SEWAZ	60
G18DBBVLW5Z	31	M8V2WSZ	98	UB18DJLL0Z	36	WR36DAW2Z	22
G18DBBVLWQZ	31			UC10SL2W0Z	47	WR36DAWRZ	22
G18DSL3Z	31	<b>N</b>		UC18YFSLW0Z	47	WR36DBW2Z	23
G18DSLW5Z	31	NR1890DBCLW9Z	34	UC18YG 0Z	48	WR36DBWRZ	23
G18DSLWUZ	31	NR1890DBCLWQZ	34	UC18YGL2W0Z	47		
G18SW2WAZ	78	NT1850DBSLJ4Z	35	UC18YKSLW0Z	47		
G18UDYWKZ	77	NT1850DBSLWXZ	35	UC18YML2W0Z	47		
G23MRUAW6Z	79	NT1865DBALJ4Z	35	UC18YRLW0Z	47		
G23MRUAWKZ	79	NT1865DBALWXZ	35	UC18YSL3W0Z	47		
G23SC3UXZ	80	NT1865DBSLJ4Z	35	UC18YSL3WEZ	45		
G23STCPZ	78	NT1865DBSLWXZ	35	UC36YSLW0Z	47		
G23STWAZ	81			UC35FLW0Z	46		
G23SW2CPZ	78	<b>P</b>		UC35MLW0Z	46		
G23SW2W7Z	80	P18DSLW2Z	33	UC7SL	46		
G23SW2WWZ	80	P18DSLW4Z	33	UF18DSALL0Z	36		
G23SWUWGZ	80	P18DSLWPZ	33	UM12VSTLAZ	63		
G23UCWKZ	79	P20SA2UAZ	97	UM16VSTLAZ	63		
G23UDYLAZ	79	P20SFVAZ	97	UR18DSALW4Z	37		
G3613DAW2Z	23			UR18DSDLW4Z	37		
G3613DAWRZ	23	<b>R</b>		UU610CZ	95		
G3613DBW2Z	23	R18DSLW4Z	36	<b>W</b>			
G3613DBWRZ	23	RB18DSL4Z	36	W4YDLAZ	58		
GP2S2UTZ	83	RH600TLAZ	108	W6V4LAZ	57		
GP3VWAZ	82	RH650VLAZ	108	W6VA4WAZ	56		
GP5VWAZ	82	RP250YDLWAZ	105	W6VB3WFZ	58		
GP10DLUCZ	43	RP250YDMWAZ	105	W6VMWAZ	57		
		RP300YDLWAZ	105	W8VB2WFZ	56		
<b>H</b>		RP350YDHVAZ	104	WF18DSL6SZ	30		
H25PVWSZ	73	RP350YDMWAZ	104	WF18DSL6Z	30		
H45MEYWTZ	72	RB40VAUTZ	106	WF18DSLUMZ	30		
H60MCWSZ	72	RP500YDMWAZ	104	WH10DALWCZ	41		
H60MEYWTZ	72			WH10DCLW4Z	42		
H65SB3WTZ	71	<b>S</b>		WH10DCLWCZ	42		
H65SD3WTZ	71	SAT180L2Z	83	WH18DBDL2W2Z	30		
H70SALAZ	71	SAY150AM1Z	83	WH18DBDL2W4Z	30		
H70SDLAZ	70	SAY150AV2Z	84	WH18DBDL2WPZ	30		
H90SGWAZ	70	SB10V2WAZ	100	WH36DBW2Z	22		
		SB8V2WAZ	100	WH36DBWRZ	22		
<b>K</b>		SP18VAUAZ	83	WM10DBLRLZ	42		
KC18DBDLWDZ	38	SV12SDUAZ	100	WM10DBLUGZ	42		
KC18DG4LWDZ	40	SV12SGWBZ	101	WR14VEWAZ	61		
KC18DPLWDZ	38						

**We make even  
your toughest job  
as easy and  
comfortable  
as possible.**





HIKOKI

BRUSHLESS  
AHB LVP

STEC

# Technologies



Bij HiKOKI geloven we dat niet alleen het design en de algemene look en feel van iedere power tool bijdragen aan het verbeteren van comfort en gebruiksgemak. Het is de technologie in de power tool die de werkzaamheden van de professional alsmäär beter maken.

### **BRUSH LESS** Brushless Motor

Met de introductie van de koolborstelloze motor in accu en elektrisch gereedschap heeft HiKOKI een werkelijke doorbraak bewerkstelligd. In beide typen machines zorgt die koolborstelloze motor, dankzij de vrijwel te verwaarlozen weerstand, voor minder slijtage en dus voor een veel langere levensduur en een hoger (constant) vermogen.

### **UVP** USER VIBRATION PROTECTION

Het in eigen huis ontwikkelde UVP systeem zorgt dat tijdens het werken het grootste deel van hinderlijke vibraties wordt voorkomen. Dat garandeert meer comfort en meer bescherming van de gewrichten.

### **IP56**

International Protection (IP) is een standaard die ontwikkeld is door de International Electrotechnical Commission (IEC). Deze geeft aan in welke mate de behuizing ervoor zorgt dat de elektronische onderdelen van de power tools beschermd zijn tegen schade van (stof)deeltjes en water.

### **MV** MULTI VOLT

Eén accupakket, twee volt-klassen - de nieuwe, innovatieve MULTI VOLT accu's. De 36 V li-ion accupakketten zijn uitwisselbaar met draadloze 18 V power tools. De intelligente verbindingstechnologie maakt het mogelijk. Afhankelijk van de power tool schakelt het voltage automatisch over naar 18 V of 36 V.

### **Li-ion**

Het geïntegreerde electronic control-circuit maakt de li-ion accu uniek. Dit circuit is voorzien van het veiligste systeem om de prestaties van deze accu te beschermen en te verbeteren. Wanneer de accu's op de juiste manier gebruikt worden, zorgt het control-circuit ervoor dat deze accu's veel vaker opgeladen kunnen worden dan conventionele accu's.

De acculaders voor 14 V, 18 V en 36 V zijn voorzien van een geïntegreerd, slim koelsysteem met ventilatoren. Wanneer een li-ion accu wordt opgeladen, circuleert er koele lucht door de batterijcellen. De cellen blijven koel en de oplader heeft zo de capaciteit om de accu tot het maximum te kunnen opladen zonder schade te veroorzaken.

### **AHB** ALUMINIUM HOUSING BODY

De dubbel geïsoleerde koolborstelloze motor is opgenomen in een zeer solide gegoten aluminium behuizing. De behuizing is robuuster en vormt een aanzienlijke verbetering van de duurzaamheid van de machine.

### **RFC** REACTIVE FORCE CONTROL

Wanneer bij overbelasting de boor of schroefbit plotseling komt klem te zitten en de machine om zijn as wil draaien treedt het ingebouwd besturingselement RFC in werking. Deze onderbreekt onmiddellijk de stroomtoevoer tot de motor.



MULTI VOLT battery

# AC power. DC freedom.

Een compleet nieuwe generatie accusystemen, die van de buitenkant oogt als een 18 V accu, maar van binnen is voorzien van de laatste technologieën. Innovaties om jouw prestaties te verbeteren. Zo zorgt het dubbele voltage voor optimale kracht, en dat zelfs draadloos. De li-ion accu's van 36 V zijn uitwisselbaar met de huidige 18 V power tools. Kortom, met slechts een simpele klik bereik jij de hoogst haalbare prestatie.



**BRUSH  
LESS**  
Brushless Motor

AC Brushless Motor series

# Everlasting efficiency.

Een unieke eigenschap van HiKOKI is de nieuwe generatie koolborstelloze motoren, zowel in accu's als in elektrische machines. Die motoren zorgen voor onverwoestbare en duurzame machines, met als unieke toevoeging dat ze als enige in de markt ook werken op netspanning. In beide type machines zorgt de koolborstelloze motor, dankzij de vrijwel te verwaarlozen weerstand, voor minder slijtage en dus voor een langere levensduur en een hoger (constant) vermogen. Dat betekent dat de boor- en breekhamers met koolborstelloze motoren in feite onderhoudsvrij zijn. Dit zorgt voor een hogere productiviteit, omdat het gereedschap langdurig en ononderbroken op de bouwplaats kan worden gebruikt.





Li-ion Nailer series

# Blending portability with power.

Ervaar dezelfde kracht als pneumatische spijkerapparaten, maar dan zonder gaspatroon en/of compressor met luchtslang. Naast het draadloze gemak bieden de HIKOKI li-ion Nailer series een ergonomische soft grip, die de werkzaamheden zo comfortabel mogelijk maken. En omdat het unieke, geïntegreerde lucht aandrijfsysteem geen gaspatronen nodig heeft, zijn onderhoud en onnodige kosten verleden tijd. De dry-fire lockout voorkomt ongewenste beschadigingen op 't materiaal, dus kun je altijd rekenen op een perfecte afwerking.





# Accu machines



### DS36DAWRZ

Accu boor-schroefmachine

EAN 4966376311507

**NEW**



Ook verkrijgbaar als **DS36DAWZ2**  
EAN 4966376311484  
Inclusief HSC II koffer.  
Exclusief accu's en lader.

**Standaard toebehoren**

2 accu's - 1 oplader - 1 zijhandgreep - 1 bit - 1 HSC II

**Technische specificaties**

Capaciteit in hout	102 mm
Capaciteit in staal	16 mm
Houtschroeven	12 x 100 mm
Machineschroeven	6 mm
Aandraaimoment	hard 138 Nm / zacht 64 Nm
Toerental onbelast hoog	0 - 2.100 tr/min.
Toerental onbelast laag	0 - 500 tr/min.
Boorkop	1,5 - 13 mm
Lengte	204 mm
Gewicht	2,7 kg
Accu (BSL36A18)	18 V - 36 V, 5,0 Ah - 2,5 Ah
Oplader	UC18YSL3



### DV36DAWRZ

Accu klop-boor-schroefmachine

EAN 4966376313334

**NEW**



Ook verkrijgbaar als **DV36DAWZ2**  
EAN 4966376313310  
Inclusief HSC II koffer.  
Exclusief accu's en lader.

**Standaard toebehoren**

2 accu's - 1 oplader - 1 zijhandgreep - 1 bit - 1 HSC II

**Technische specificaties**

Capaciteit in hout	102 mm
Capaciteit in staal	16 mm
Capaciteit in steen	20 mm
Houtschroeven	12 x 100 mm
Machineschroeven	6 mm
Aandraaimoment	hard 138 Nm / zacht 64 Nm
Toerental onbelast hoog	0 - 2.100 tr/min.
Toerental onbelast laag	0 - 500 tr/min.
Aantal slagen hoog	0 - 31.500 /min.
Aantal slagen laag	0 - 7.500 /min.
Boorkop	1,5 - 13 mm
Lengte	204 mm
Gewicht	2,7 kg
Accu (BSL36A18)	18 V - 36 V, 5,0 Ah - 2,5 Ah
Oplader	UC18YSL3



### DH36DPAWRZ

Accu boorhamer

EAN 4966376307883

**NEW**



Ook verkrijgbaar als **DH36DPAWZ2**  
EAN 4966376307869  
Inclusief HSC IV koffer.  
Exclusief accu's en lader.



**Standaard toebehoren**

2 accu's - 1 oplader - 1 zijhandgreep - 1 diepteanslag  
1 HSC IV

**Technische specificaties**

Capaciteit in hout	32 mm
Capaciteit in staal	13 mm
Capaciteit in beton	28 mm
Toerental onbelast	0 - 1.100 tr/min.
Aantal slagen belast	0 - 4.300 /min.
Slagenergie	3 J
L x H	351 x 220 mm
Gewicht	3,9 kg
Accu (BSL36A18)	18 V - 36 V, 5,0 Ah - 2,5 Ah
Oplader	UC18YSL3



## DH36DPAWRDZ

Accu boorhamer met stofafzuigunit

EAN 8717574061598

**NEW**



Ook verkrijgbaar als  
DH36DPAW2DZ

EAN 8717574061581

Inclusief HSC IV koffer en stofafzuigunit in HSC II.

Exclusief accu's en lader.

### Standaard toebehoren

2 accu's - 1 oplader - 1 zijhandgreep - 1 diepteanslag  
1 HSC IV - 1 stofafzuigunit in HSC II



### Technische specificaties

Capaciteit in hout	32 mm
Capaciteit in staal	13 mm
Capaciteit in beton	28 mm
Toerental onbelast	0 - 1.100 tr/min.
Aantal slagen belast	0 - 4.300 /min.
Slagenergie	3 J
L x H	493 x 314 mm
Gewicht	5,7 kg
Accu (BSL36A18)	18 V - 36 V, 5.0 Ah - 2.5 Ah
Oplader	UC18YSL3

## WH36DBWRZ

Accu slagschroevendraaier

EAN 4966376321582

**NEW**



Ook verkrijgbaar als

WH36DBW2Z

EAN 4966376321568

Inclusief HSC II koffer.

Exclusief accu's en lader.

### Standaard toebehoren

2 accu's - 1 oplader - 1 accu beschermkap - 1 HSC II

Schroeven	4 - 10 mm
Zelfborende schroeven	3,5 - 6 mm
Bouten en moeren	M5 - M18
Aandraaimoment	210 Nm
Toerental onbelast zacht	0 - 900 tr/min.



Toerental onbelast	0 - 2.900 tr/min.
normaal/power	0 - 2.900 tr/min.
Toerental onbelast zelfborend	0 - 2.000 /min.
Aantal slagen belast zacht	0 - 2.000 /min.
Aantal slagen belast normaal/power	0 - 4.100 /min.
Aantal slagen belast zelfborend	0 - 2.200 /min.
Lengte	127 mm
Gewicht	1,6 kg
Accu (BSL36A18)	18 V - 36 V, 5.0 Ah - 2.5 Ah
Oplader	UC18YSL3

## WR36DAWRZ

Accu slagmoeraanzetter

EAN 4966376323623

**NEW**



Ook verkrijgbaar als

WR36DAW2Z

EAN 4966376323609

Inclusief HSC II koffer.

Exclusief accu's en lader.

### Standaard toebehoren

2 accu's - 1 oplader - 1 accu beschermkap - 1 HSC II

### Technische specificaties

Bouten en moeren	M12 - M30
High tension moer	M10 - M24
Aandraaimoment	1.180 Nm
Losdraaimoment	1.800 Nm
Toerental onbelast hoog	0 - 1.500 tr/min.
Toerental onbelast medium	0 - 1.200 tr/min.
Toerental onbelast laag 2	0 - 900 tr/min.
Toerental onbelast laag 1	0 - 600 tr/min.
Aantal slagen hoog	0 - 2.900 /min.
Aantal slagen medium	0 - 2.300 /min.
Aantal slagen laag 2	0 - 1.800 /min.
Aantal slagen laag 1	0 - 1.200/min.
Gereedschapsopname	3/4" vierkant
L x H	221 x 290 mm
Gewicht	3,7 kg
Accu (BSL36A18)	18 V - 36 V, 5.0 Ah - 2.5 Ah
Oplader	UC18YSL3



### WR36DBWRZ

Accu slagmoeraanzetter

EAN 4966376323814

**NEW**



Ook verkrijgbaar als  
**WR36DBWZ**  
EAN 4966376323791  
Inclusief HSC II koffer.  
Exclusief accu's en lader.

#### Standaard toebehoren

2 accu's - 1 oplader - 1 accu beschermkap - 1 HSC II

#### Technische specificaties

Bouten en moeren	M12 - M30
High tension moer	M10 - M24
Aandraaimoment	1.130 Nm
Losdraaimoment	1.650 Nm
Toerental onbelast hoog	0 - 1.500 tr/min.
Toerental onbelast medium	0 - 1.200 tr/min.
Toerental onbelast laag 2	0 - 900 tr/min.
Toerental onbelast laag 1	0 - 600 tr/min.
Aantal slagen hoog	0 - 2.800 /min.
Aantal slagen medium	0 - 2.300 /min.
Aantal slagen laag 2	0 - 1.800 /min.
Aantal slagen laag 1	0 - 1.200 /min.
Gereedschapsopname	1/2" vierkant
L x H	221 x 290 mm
Gewicht	3,7 kg
Accu (BSL36A18)	18 V - 36 V, 5,0 Ah - 2,5 Ah
Oplader	UC18YSL3



### G3613DAWRZ

Accu haakse slijpmachine met rem

EAN 4966376314997

**NEW**



Ook verkrijgbaar als  
**G3613DAWZ**  
EAN 4966376311484  
Inclusief HSC II koffer.  
Exclusief accu's en lader.

#### Standaard toebehoren

2 accu's - 1 oplader - 1 zijhandgreep - 1 sleutel - 1 HSC II

#### Technische specificaties

Diameter slijpschijf	125 mm
Toerental onbelast A/mode	5.500 - 9.500 tr/min.
Toerental onbelast 1 - 5 standen	3.000 - 9.500 tr/min.
Spindel	M14
Vibratieniveau onbelast	5,9 m/sec <sup>2</sup> .
Lengte	358 mm
Greepdiameter	146 mm
Gewicht (EPTA)	2,8 kg
Accu (BSL36A18)	18 V - 36 V, 5,0 Ah - 2,5 Ah
Oplader	UC18YSL3



### G3613DBWRZ

Accu haakse slijpmachine met rem

EAN 4966376315055

**NEW**



Ook verkrijgbaar als  
**G3613DBWZ**  
EAN 4966376315048  
Inclusief HSC II koffer.  
Exclusief accu's en lader.

#### Standaard toebehoren

2 accu's - 1 oplader - 1 zijhandgreep - 1 sleutel - 1 HSC II

#### Technische specificaties

Diameter slijpschijf	125 mm
Toerental onbelast A/mode	5.500 - 9.500 tr/min.
Toerental onbelast 1 - 5 standen	3.000 - 9.500 tr/min.
Spindel	M14
Vibratieniveau onbelast	5,9 m/sec <sup>2</sup> .
Lengte	358 mm
Greepdiameter	146 mm
Gewicht (EPTA)	2,8 kg
Accu (BSL36A18)	18 V - 36 V, 5,0 Ah - 2,5 Ah
Oplader	UC18YSL3



## C3606DAWRZ

Accu cirkelzaag

EAN 4966376302321

**NEW**



Ook verkrijgbaar als  
**C3606DAW2Z**  
EAN 4966376302314  
Inclusief HSC IV koffer.  
Exclusief accu's en lader.

### Standaard toebehoren

2 accu's - 1 oplader - 1 sleutel - 1 langsgelider - 1 HSC IV



### Technische specificaties

Diameter zaagblad	165 mm
Zaagdiepte	66 mm
In verstek 45°	45 mm
In verstek - 5°	57 mm
Toerental onbelast S/mode	2.000 tr/min.
Toerental onbelast P/mode	4.300 tr/min.
L x B x H	292 x 188 x 262 mm
Gewicht	3,4 kg
Accu (BSL36A18)	18 V - 36 V, 5,0 Ah - 2,5 Ah
Oplader	UC18YSL3

## 714959

Stofafzuigunit in HSC II

EAN 8717574054798

**TNO** innovation  
for life



### Standaard toebehoren

1 HSC II

### Stofvrij werken

In de bouw is stofvrij werken sinds 2013 de norm. De grote hoeveelheden kwarts- en fijnstof - die vrijkomen bij zagen en boren in steensoorten - kunnen niet alleen leiden tot hoge boetes, maar vooral tot blijvende gezondheidsschade aan de longen. Hitachi levert stofafzuigsystemen voor nagenoeg elke machine.

### Verantwoord gebruik in kalkzandsteen

1.000 boorgaten per 8-urige werkdag.



### Verantwoord gebruik in beton/baksteen

1.750 boorgaten per 8-urige werkdag.

## DS18DBL2WPZ

Accu boor-schroefmachine

EAN 4966376310265



Ook verkrijgbaar als

**DS18DBL2W2Z**

EAN 4966376310241

Inclusief HSC II koffer.

Exclusief accu's en lader.

**DS18DBL2W4Z**

EAN 4966376310258

In kartonnen doos.

Exclusief HSC II koffer, accu's en lader.

### Standaard toebehoren

2 accu's - 1 oplader - 1 zijhandgreep - 1 bit - 1 HSC II

### Technische specificaties

Capaciteit in hout	76 mm
Capaciteit in staal	13 mm
Houtschroeven	10 x 90 mm
Max. aandraaimoment hard	136 Nm
Max. aandraaimoment zacht	62 Nm
Toerental onbelast hoog	0 - 2.100 tr/min.
Toerental onbelast laag	0 - 500 tr/min.
Capaciteit boorhouder	13 mm
L x H	204 x 257 mm
Gewicht	2,5 kg
Accu	BSL1850, 18 V, 5,0 Ah
Oplader	UC18YFSL, 220 V, 50/60 Hz





### DS18DBSLWFZ

Accu boor-schroefmachine

EAN 4966376326297

**NEW**

**BRUSH LESS**  
Brushless Motor  
**5.0Ah**  
Lithium



Ook verkrijgbaar als  
**DS18DBSLW6Z**

EAN 4966376326235

Inclusief HSC II koffer.

Exclusief accu's en lader.

**DS18DBSLW3Z**

EAN 4966376326259

In kartonnen doos.

Exclusief HSC II koffer, accu's en lader.

**Standaard toebehoren**  
2 accu's - 1 oplader - 1 HSC II

**Technische specificaties**

Capaciteit in hout	50 mm
Capaciteit in staal	13 mm
Houtschroeven	8 x 100 mm
Machineschroeven	6 mm
Max. aandraaimoment hard	70 Nm
Max. aandraaimoment zacht	40 Nm
Toerental onbelast hoog	0 - 1.800 tr/min.
Toerental onbelast laag	0 - 400 tr/min.
Lengte	175 mm
Gewicht	1,9 kg
Accu	BSL1850, 18 V, 5,0 Ah
Oplader	UC18YFSL, 220 V, 50/60 Hz



### DS18DBSLWNZ

Accu boor-schroefmachine

EAN 4966376326310

**NEW**

**BRUSH LESS**  
Brushless Motor  
**3.0Ah**  
Lithium



**Standaard toebehoren**  
2 accu's - 1 oplader - 1 HSC II

**Technische specificaties**

Capaciteit in hout	50 mm
Capaciteit in staal	13 mm
Houtschroeven	8 x 100 mm
Machineschroeven	6 mm
Max. aandraaimoment hard	70 Nm
Max. aandraaimoment zacht	40 Nm
Toerental onbelast hoog	0 - 1.800 tr/min.
Toerental onbelast laag	0 - 400 tr/min.
Lengte	175 mm
Gewicht	1,6 kg
Accu	BSL1830C, 18 V, 3,0 Ah
Oplader	UC18YFSL, 220 V, 50/60 Hz



### DS18DSDLWPZ

Accu boor-schroefmachine

EAN 4966376311286

**5.0Ah**  
Lithium



Ook verkrijgbaar als

**DS18DSDL2Z**

EAN 4966376311200

Inclusief HSC II koffer.

Exclusief accu's en lader.

**DS18DSDLW4Z**

EAN 4966376311255

In kartonnen doos.

Exclusief HSC II koffer, accu's en lader.

**Standaard toebehoren**  
2 accu's - 1 oplader - 1 kruiskopbit nr. 2 - 1 zijhandgreep  
1 HSC II

**Technische specificaties**

Capaciteit in hout	65 mm
Capaciteit in staal	13 mm
Houtschroeven	8 x 100 mm
Machineschroeven	6 mm
Max. aandraaimoment hard	92 Nm
Max. aandraaimoment zacht	46 Nm
Toerental onbelast hoog	0 - 1.600 tr/min.
Toerental onbelast laag	0 - 350 tr/min.
Capaciteit boorhouder	13 mm
Lengte	228 mm
Gewicht	2,1 kg
Accu	BSL1850, 18 V, 5,0 Ah
Oplader	UC18YFSL, 220 V, 50/60 Hz



## DS18DJLWCZ

Accu schroefmachine

EAN 4966376310845

**1.5Ah**  
Li-Ion



### Standaard toebehoren

2 accu's - 1 oplader - 1 kunststof koffer

### Technische specificaties

Capaciteit in hout	38 mm
Capaciteit in staal	13 mm
Hout Schroeven	6,8 x 50 mm
Machineschroeven	6 mm
Aandraaimoment	1 - 6 Nm
Max. aandraaimoment	53 Nm
Toerental onbelast hoog	0 - 1.250 tr/min.
Toerental onbelast laag	0 - 450 tr/min.
Capaciteit boorhouder	13 mm
Lengte	213 mm
Gewicht	1,7 kg
Accu	BSL1815, 18 V, 1,5 Ah
Oplader	UC18YKSL, 220 V, 50/60 Hz



## DS18DJLWQZ

Accu schroefmachine

EAN 4966376310883

**3.0Ah**  
Li-Ion



### Standaard toebehoren

2 accu's - 1 oplader - 1 HSC II

### Technische specificaties

Capaciteit in hout	38 mm
Capaciteit in staal	13 mm
Hout Schroeven	6,8 x 50 mm
Zelfborende schroeven	6 mm
Aandraaimoment	1 - 6 Nm
Max. aandraaimoment	53 Nm
Toerental onbelast hoog	0 - 1.250 tr/min.
Toerental onbelast laag	0 - 450 tr/min.
Capaciteit boorhouder	13 mm
Lengte	213 mm
Gewicht	1,7 kg
Accu	BSL1830, 18 V, 3,0 Ah
Oplader	UC18YKSL, 220 V, 50/60 Hz



## DS18DJLWLZ

Accu schroefmachine met lamp

EAN 4966376328666

**NEW**

**1.5Ah**  
Li-Ion



### Standaard toebehoren

2 accu's - 1 oplader - 1 lamp - 1 kunststof koffer

### Technische specificaties

Capaciteit in hout	38 mm
Capaciteit in staal	13 mm
Hout Schroeven	6,8 x 50 mm
Zelfborende schroeven	6 mm
Aandraaimoment	1 - 6 Nm
Max. aandraaimoment	53 Nm
Toerental onbelast hoog	0 - 1.250 tr/min.
Toerental onbelast laag	0 - 450 tr/min.
Capaciteit boorhouder	13 mm
Lengte	213 mm
Gewicht	1,7 kg
Accu	BSL1830, 18 V, 3,0 Ah
Oplader	UC18YKSL, 220 V, 50/60 Hz



### DV18DBL2WPZ

Accu klop-boor-schroefmachine

EAN 4966376312290



Ook verkrijgbaar als  
**DV18DBL2W2Z**

EAN 4966376312269

Inclusief HSC II koffer.

Exclusief accu's en lader.

**DV18DBL2W4Z**

EAN 4966376312276

In kartonnen doos.

Exclusief HSC II koffer, accu's en lader.

#### Standaard toebehoren

2 accu's - 1 oplader - 1 zijhandgreep - 1 bit - 1 HSC II

#### Technische specificaties

Capaciteit in hout	76 mm
Capaciteit in staal	13 mm
Capaciteit in steen	16 mm
Hout Schroeven	10 x 90 mm
Machineschroeven	6 mm
Max. aandraaimoment hard	136 Nm
Max. aandraaimoment zacht	62 Nm
Toerental onbelast hoog	0 - 2.100 tr/min.
Toerental onbelast laag	0 - 500 tr/min.
Aantal slagen	0 - 31.500 /min.
Capaciteit boorhouder	13 mm
L x H	204 x 257 mm
Gewicht	2,5 kg
Accu	BSL1850, 18 V, 5.0 Ah
Oplader	UC18YFSL, 220 V, 50/60 Hz



### DV18DBSLWPZ

Accu klop-boor-schroefmachine

EAN 4966376326419

**NEW**



#### Standaard toebehoren

2 accu's - 1 oplader - HSC II

#### Technische specificaties

Capaciteit in hout	50 mm
Capaciteit in staal	13 mm
Capaciteit in steen	13 mm
Hout Schroeven	8 x 100 mm
Machineschroeven	6 mm
Max. aandraaimoment hard	70 Nm
Max. aandraaimoment zacht	40 Nm
Toerental onbelast hoog	0 - 1.800 tr/min.
Toerental onbelast laag	0 - 400 tr/min.
Aantal slagen hoog	0 - 27.000 /min.
Aantal slagen laag	0 - 6.000 /min.
Lengte	184 mm
Gewicht	2 kg
Accu	BSL1850, 18 V, 5.0 Ah
Oplader	UC18YFSL, 220 V, 50/60 Hz

Ook verkrijgbaar als

**DV18DBSLW6Z**

EAN 4966376326358

Inclusief HSC II koffer.

Exclusief accu's en lader.

**DV18DBSLW3Z**

EAN 4966376326372

In kartonnen doos.

Exclusief HSC II koffer, accu's en lader.



## DV18DSDLWPZ

Accu klop-boor-schroefmachine

EAN 4966376313181

**5.0Ah**  
Li-Ion



Ook verkrijgbaar als  
**DV18DSDLW4S2**

EAN 8717574061635

Inclusief HSC II koffer.

Exclusief accu's en lader.

**DV18DSDLW4Z**

EAN 4966376313143

In kartonnen doos.

Exclusief HSC II koffer, accu's en lader.

### Standaard toebehoren

2 accu's - 1 oplader - 1 kruiskopbit nr. 2 - 1 zijhandgreep  
1 HSC II

### Technische specificaties

Capaciteit in hout	65 mm
Capaciteit in staal	13 mm
Capaciteit in steen	16 mm
Hout Schroeven	8 x 100 mm
Machineschroeven	6 mm
Max. aandraaimoment hard	92 Nm
Max. aandraaimoment zacht	43 Nm
Toerental onbelast hoog	0 - 1.800 tr/min.
Toerental onbelast laag	0 - 400 tr/min.
Aantal slagen belast	0 - 27.000 /min.
Capaciteit boorhouder	13 mm
Lengte	242 mm
Gewicht	2,2 kg
Accu	BSL1850, 18 V, 5.0 Ah
Oplader	UC18YFSL, 220 V, 50/60 Hz



## DN18DSLLEZ

Accu haakse boor-schroefmachine

EAN 4966376308538

**2.5Ah**  
Li-Ion



Ook verkrijgbaar als  
**DN18DSL2Z**

EAN 4966376308491

Inclusief HSC II koffer.

Exclusief accu's en lader.

**DN18DSL4Z**

EAN 4966376308507

In kartonnen doos.

Exclusief HSC II koffer, accu's en lader.

### Standaard toebehoren

2 accu's - 1 oplader - 1 zijhandgreep - 1 HSC II

### Technische specificaties

Capaciteit in hout	28 mm
Capaciteit in staal	10 mm
Max. aandraaimoment	12,5 Nm
Toerental onbelast	0 - 1.800 tr/min.
Capaciteit boorhouder	10 mm
L x H	326 x 88 mm
Gewicht	1,7 kg
Accu	BSL1825, 18 V, 2.5 Ah
Oplader	UC18YFSL, 220 V, 50/60 Hz



## DH18DBLWPDZ

Accu boorhamer met stofafzuigunit

EAN 8717574061628

**BRUSH LESS**  
Brushless Motor  
**RFC**  
REACTIVE FORCE CONTROL  
**5.0Ah**  
Li-Ion



Ook verkrijgbaar als  
**DH18DBLW2DZ**

EAN 8717574061611

Inclusief HSC IV koffer en

stofafzuigunit in HSC II.

Exclusief accu's en lader.

### Standaard toebehoren

2 accu's - 1 oplader - 1 zijhandgreep - 1 diepteaanslag  
1 HSC IV - 1 stofafzuigunit in HSC II

### Technische specificaties

Capaciteit in staal	13 mm
Capaciteit in beton	26 mm
Slagenergie	2,2 J
Toerental onbelast	0 - 1.050 tr/min.
Aantal slagen belast	0 - 3.950 /min.
Lengte	493 mm
Gewicht	5,5 kg
Accu	BSL1850, 18 V, 5.0 Ah
Oplader	UC18YFSL, 220 V, 50/60 Hz



### DH18DBLWPZ

Accu boorhamer

EAN 4966376306541



Ook verkrijgbaar als  
**DH18DBLW2Z**

EAN 4966376306510

Inclusief HSC IV koffer.  
Exclusief accu's en lader.

**DH18DBLW4Z**

EAN 4966376306527

In kartonnen doos.  
Exclusief HSC IV koffer, accu's en lader.

	<b>Standaard toebehoren</b> 2 accu's - 1 oplader - 1 zijhandgreep - 1 diepteanslag 1 HSC IV
	<b>Technische specificaties</b>
	Capaciteit in staal 13 mm
	Capaciteit in beton 26 mm
	Slagenergie 2,2 J
	Toerental onbelast 0 - 1.050 tr/min.
	Aantal slagen belast 0 - 3.950 /min.
	Lengte 351 mm
	Gewicht 3,7 kg
	Accu BSL1850, 18 V, 5.0 Ah
	Oplader UC18YFSL, 220 V, 50/60 Hz

### WR18DSHLWPZ

Accu slagmoeraanzetter

EAN 4966376323418



Ook verkrijgbaar als  
**WR18DSHLL2Z**

EAN 4966376323326

Inclusief HSC III koffer.  
Exclusief accu's en lader.

**WR18DSHLW4Z**

EAN 4966376323388

In kartonnen doos.  
Exclusief HSC III koffer, accu's en lader.

	<b>Standaard toebehoren</b> 2 accu's - 1 oplader - 1 HSC III
	<b>Technische specificaties</b>
	Bouten en moeren M12 - M22
	Max. aandraaimoment 480 Nm
	Toerental onbelast 1.500 tr/min.
	Aantal slagen belast 2.000 /min.
	Gereedschapsopname 1/2" vierkant
	L x H 263 x 295 mm
	Gewicht 3,4 kg
	Accu BSL1850, 18 V, 5.0 Ah
	Oplader UC18YFSL, 220 V, 50/60 Hz

### WR18DBDL2WPZ

Accu slagmoeraanzetter

EAN 4966376322763



Ook verkrijgbaar als  
**WR18DBDL2W2Z**

EAN 4966376322718

Inclusief HSC II koffer.  
Exclusief accu's en lader.

**WR18DBDL2W4Z**

EAN 4966376322725

In kartonnen doos.  
Exclusief HSC II koffer, accu's en lader.

	<b>Standaard toebehoren</b> 2 accu's - 1 oplader - 1 HSC II
	<b>Technische specificaties</b>
	Bouten en moeren M10 - M20
	Max. aandraaimoment 305 Nm
	Toerental onbelast hoog 2.700 tr/min.
	Toerental onbelast medium 2.000 tr/min.
	Toerental onbelast laag 0 - 1.000 tr/min.
	Aantal slagen belast 0 - 3.600 /min.
	Gereedschapsopname 1/2" vierkant
	L x H 145 x 244 mm
	Gewicht 1,8 kg
	Accu BSL1850, 18 V, 5.0 Ah
	Oplader UC18YFSL, 220 V, 50/60 Hz

## WH18DBDL2WPZ

Accu slagschroevendraaier

EAN 4966376320899



Ook verkrijgbaar als

**WH18DBDL2WZ**

EAN 4966376320851

Inclusief HSC II koffer.

Exclusief accu's en lader.

**WH18DBDL2W4Z**

EAN 4966376320868

In kartonnen doos.

Exclusief HSC II koffer, accu's en lader.

### Standaard toebehoren

2 accu's - 1 oplader - 1 HSC II

### Technische specificaties

Houtschroeven 4 - 10 mm  
Bouten en moeren M5 - M18  
Max. aandraaimoment 207 Nm



Toerental onbelast - zacht 0 - 900 tr/min.  
- normaal/power 0 - 2.900 tr/min.



Toerental onbelast zelfborend 0 - 2.900 tr/min.



Aantal slagen belast - zacht 0 - 1.900 /min.



- normaal/power 0 - 4.000 /min.



Aantal slagen belast zelfborend 0 - 2.100 /min

L x H 127 x 240 mm



Gewicht 1,6 kg

Accu BSL1850, 18 V, 5.0 Ah

Oplader UC18YFSL, 220 V, 50/60 Hz

## WF18DSLUMZ

Accu snelschroefautomaat

EAN 4966376319855



Ook verkrijgbaar als

**WF18DSLUM6Z**

EAN 8717574061642

Inclusief HSC III koffer.

Exclusief accu's en lader.

**WF18DSLUMZ**

EAN 4966376319848

In kartonnen doos.

Exclusief HSC III koffer, accu's en lader.

### Standaard toebehoren

2 accu's - 1 oplader - 2 kruiskopbits nr. 2

2 beschermstukken - 1 HSC III

### Technische specificaties

Houtschroeven D4 x L25 - 41 mm  
Gipsplaat Schroeven D3.6/3.9 x L25 - 35 mm  
Toerental onbelast 4.200 tr/min.



Geluidsniveau 74 dB



L x H 379 x 192 mm



Gewicht 2,1 kg



Accu BSL1850, 18 V, 5.0 Ah

Oplader UC18YFSL, 220 V, 50/60 Hz

## C18DBALWPZ

Accu cirkelzaag

EAN 4966376301768



Ook verkrijgbaar als

**C18DBALW2Z**

EAN 4966376301744

Inclusief HSC IV koffer.

Exclusief accu's en lader.

**C18DBALW4Z**

EAN 4966376301751

In kartonnen doos.

Exclusief HSC IV koffer, accu's en lader.

### Standaard toebehoren

2 accu's - 1 oplader - 1 sleutel 10 mm - 1 langsgelider

1 HSC IV

### Technische specificaties

Diameter zaagblad 165 mm

Zaagdiepte 66 mm

In verstek 45° 45 mm

Asgat 20 mm



Toerental onbelast S/mode 2.500 tr/min.



Toerental onbelast P/mode 4.100 tr/min.



L x B x H 294 x 188 x 255 mm



Gewicht 3,2 kg

Accu BSL1850, 18 V, 5.0 Ah

Oplader UC18YFSL, 220 V, 50/60 Hz

### G18DBBVLWQZ

Accu haakse slijpmachine met rem

EAN 4966376314157



Ook verkrijgbaar als

**G18DBBVLW2Z**

EAN 4966376314126

Inclusief HSC II koffer.

Exclusief accu's en lader.

**G18DBBVLW5Z**

EAN 4966376314133

In kartonnen doos.

Exclusief HSC II koffer, accu's en lader.



**Standaard toebehoren**

2 accu's - 1 oplader - 1 zijhandgreep - 1 sleutel - 1 HSC II



**Technische specificaties**

Diameter slijpschijf	125 mm
Toerental onbelast S/mode	5.500 tr/min.
Toerental onbelast P/mode	4.700 - 9.000 tr/min.
Greepdiameter	152 mm
L x H	326 x 126 mm
Gewicht	2,4 kg
Accu	BSL1850, 18 V, 5,0 Ah
Oplader	UC18YFSL, 220 V, 50/60 Hz



### G18DBBALWQZ

Accu haakse slijpmachine met rem

EAN 4966376314065



Ook verkrijgbaar als

**G18DBBALW2Z**

EAN 4966376314034

Inclusief HSC II koffer.

Exclusief accu's en lader.

**G18DBBALW5Z**

EAN 4966376314058

In kartonnen doos.

Exclusief HSC II koffer, accu's en lader.



**Standaard toebehoren**

2 accu's - 1 oplader - 1 zijhandgreep - 1 sleutel - 1 HSC II



**Technische specificaties**

Diameter slijpschijf	125 mm
Toerental onbelast S/mode	5.500 tr/min.
Toerental onbelast P/mode	9.000 tr/min.
Greepdiameter	152 mm
L x H	326 x 126 mm
Gewicht	2,3 kg
Accu	BSL1850, 18 V, 5,0 Ah
Oplader	UC18YFSL, 220 V, 50/60 Hz



### G18DBBLWQZ

Accu haakse slijpmachine met rem

EAN 4966376314102



Ook verkrijgbaar als

**G18DBBLW2Z**

EAN 4966376314072

Inclusief HSC II koffer.

Exclusief accu's en lader.

**G18DBBLW5Z**

EAN 4966376314089

In kartonnen doos.

Exclusief HSC II koffer, accu's en lader.



**Standaard toebehoren**

2 accu's - 1 oplader - 1 zijhandgreep - 1 sleutel - 1 HSC II



**Technische specificaties**

Diameter slijpschijf	125 mm
Toerental onbelast S/mode	5.500 tr/min.
Toerental onbelast P/mode	9.000 tr/min.
Greepdiameter	152 mm
L x H	326 x 126 mm
Gewicht	2,3 kg
Accu	BSL1850, 18 V, 5,0 Ah
Oplader	UC18YFSL, 220 V, 50/60 Hz



### G18DSLWUZ

Accu haakse slijpmachine

EAN 4966376314850



Ook verkrijgbaar als

**G18DSL3Z**

EAN 4966376314737

Inclusief HSC II koffer.

Exclusief accu's en lader.

**G18DSLW5Z**

EAN 4966376314805

In kartonnen doos.

Exclusief HSC II koffer, accu's en lader.



**Standaard toebehoren**

2 accu's - 1 oplader - 1 zijhandgreep - 1 sleutel - 1 HSC II



**Technische specificaties**

Diameter slijpschijf	125 mm
Toerental onbelast laag	9.100 tr/min.
Greepdiameter	182 mm
L x B x H	296 x 65 x 135 mm
Gewicht	1,9 kg
Accu	BSL1850, 18 V, 5,0 Ah
Oplader	UC18YFSL, 220 V, 50/60 Hz



## CJ18DSLWPZ

Accu decoupeerzaag

EAN 4966376304097

**5.0Ah**  
Li-Ion



Ook verkrijgbaar als  
**CJ18DSL2Z**

EAN 4966376304004

Inclusief HSC III koffer.

Exclusief accu's en lader.

**CJ18DSLW4Z**

EAN 4966376304066

In kartonnen doos.

Exclusief HSC III koffer, accu's en lader.

### Standaard toebehoren

2 accu's - 1 oplader - 1 anti-splinterplaatje - 1 beschermkapje  
1 zaagblad - 1 HSC III

### Technische specificaties

Capaciteit in hout	135 mm
Capaciteit in staal	10 mm
Kleine radius	25 mm
In verstek	0 - 45°
Toerental onbelast	0 - 2.400 tr/min.
Slaglengte	26 mm
L x B x H	268 x 76 x 312 mm
Gewicht	2,4 kg
Accu	BSL1850, 18 V, 5,0 Ah
Oplader	UC18YFSL, 220 V, 50/60 Hz



## CR18DBLWJZ

Accu reciprozaag

EAN 4966376304943

**BRUSH**  
LESS  
Brushless Motor

**5.0Ah**  
Li-Ion



Ook verkrijgbaar als  
**CR18DBLW4SZ**

EAN 8717574061659

Inclusief HSC IV koffer.

Exclusief accu's en lader.

**CR18DBLW4Z**

EAN 4966376304936

In kartonnen doos.

Exclusief HSC IV koffer, accu's en lader.

### Standaard toebehoren

2 accu's - 1 oplader - 1 kunststof koffer

### Technische specificaties

Capaciteit in hout	120 mm
Capaciteit in staal	19 mm
Max. diam. ronde stalen buis	130 mm
Slaglengte	32 mm
AT mode	1.600/2.500 min.
Toerental onbelast	0 - 1.600/2.300/2.500 tr/min.
Lengte	435 mm
Gewicht	3,4 kg
Accu	BSL1850, 18 V, 5,0 Ah
Oplader	UC18YFSL, 220 V, 50/60 Hz



## CL18DSLUIUZ

Accu draadeindknipper

EAN 4966376304370

**5.0Ah**  
Li-Ion



Ook verkrijgbaar als  
**CL18DSLUI6SZ**

EAN 8717574061666

Inclusief HSC III koffer.

Exclusief accu's en lader.

**CL18DSLUI6Z**

EAN 4966376304363

In kartonnen doos.

Exclusief HSC III koffer, accu's en lader.

### Standaard toebehoren

2 accu's - 1 oplader - 1 set snijmesses M8 - 1 ontbramer M8  
1 kunststof koffer

### Technische specificaties

Capaciteit	M6, M8, M10, W3/8", W5/16"
Minimale snijlengte	24 mm
Lengte	283 mm
Greepdiameter	102 mm
Gewicht	3,2 kg
Accu	BSL1850, 18 V, 5,0 Ah
Oplader	UC18YFSL, 220 V, 50/60 Hz





### P18DSLWPZ

Accu schaafmachine

EAN 4966376317028

**5.0Ah**  
Lithium



Ook verkrijgbaar als

**P18DSLW2Z**

EAN 4966376316991

Inclusief HSC III koffer.

Exclusief accu's en lader.

**P18DSLW4Z**

EAN 4966376317004

In kartonnen doos.

Exclusief HSC III koffer, accu's en lader.

#### Standaard toebehoren

2 accu's - 1 oplader - 1 langsgelieder - 1 HSC III

#### Technische specificaties

Schaafbreedte	82 mm
Sponningdiepte	9 mm
Spaandikte	2 mm
Toerental	16.000 tr/min.
L x B x H	326 x 166 x 160 mm
Gewicht	3,3 kg
Accu	BSL1850, 18 V, 5.0 Ah
Oplader	UC18YFSL, 220 V, 50/60 Hz



### CV18DBLWPZ

Accu multi tool

EAN 4966376305933

**BRUSH LESS**  
Brushless Motor

**ACS**  
ACTIVE CONTROL SYSTEM

**5.0Ah**  
Lithium



Ook verkrijgbaar als

**CV18DBLW2Z**

EAN 4966376305858

Inclusief HSC II koffer.

Exclusief accu's en lader.

**CV18DBLW4Z**

EAN 4966376305865

In kartonnen doos.

Exclusief HSC II koffer, accu's en lader.

#### Standaard toebehoren

2 accu's - 1 oplader - 1 deltaschuurplateau 93 mm  
5 deltaschuurbladen hout 93 mm (#60/#80/#100/#120/#180)  
1 BIM segmentzaagblad hout en metaal, 28 mm  
1 HCS-invalzaagblad hout, 85 mm - 1 HSC II

#### Technische specificaties



Oscillatie snelheid	6.000 - 20.000 /min.
Auto-Modus	15.000 - 20.000 /min.
Gereedschapopname	OIS
L x H	307 x 103 mm
Gewicht	2 kg
Accu	BSL1850, 18 V, 5.0 Ah
Oplader	UC18YFSL, 220 V, 50/60 Hz

### CB18DBLWJZ

Accu lintzaag

EAN 4966376302390

**BRUSH LESS**  
Brushless Motor

**ACS**  
ACTIVE CONTROL SYSTEM

**5.0Ah**  
Lithium



Ook verkrijgbaar als

**CB18DBLW4SZ**

EAN 8717574061673

Inclusief HSC IV koffer.

Exclusief accu's en lader.

**CB18DBLW4Z**

EAN 4966376302383

In kartonnen doos.

Exclusief HSC IV koffer, accu's en lader.

#### Standaard toebehoren

2 accu's - 1 oplader - 1 lintzaag - 1 zijhandgreep  
1 inbusleutel

#### Technische specificaties



Max. diam. ronde stalen buis	83 mm
Max. diam. vierkante stalen buis	80 x 80 mm
Lintzaag L x B	900 x 12,5 mm
Bandsnelheid (1 - 5)	80 - 195 m/min.
Bandsnelheid (AT-mode)	120 - 195 m/min.
L x B x H	413 x 173 x 266 mm
Gewicht	3,5 kg
Accu	BSL1850, 18 V, 5.0 Ah
Oplader	UC18YSL3, 220 V, 50/60 Hz

## CN18DSLWPZ

Accu knabbelschaar (14,4 V/18 V)

EAN 4966376304509

**BRUSH  
LESS**  
Brushless Motor

**5.0Ah**  
Li-Ion



Ook verkrijgbaar als  
**CN18DSLW4SZ**

EAN 8717574061680

Inclusief HSC II koffer.

Exclusief accu's en lader.

**CN18DSLW4Z**

EAN 4966376304462

In kartonnen doos.

Exclusief HSC II koffer, accu's en lader.

### Standaard toebehoren

2 accu's - 1 oplader - 2 sleutels - 1 HSC II

### Technische specificaties

Capaciteit in staal	1,6 mm
Capaciteit in RVS	1,2 mm
Kleinste radius	40 mm
Geluidsniveau	79 dB
Lengte	295 mm
Gewicht	2,0 kg
Accu	BSL1850, 18 V, 5.0 Ah
Oplader	UC18YFSL, 220 V, 50/60 Hz



## CE18DSLWPZ

Accu plaatschaar (14,4 V/18 V)

EAN 4966376302505

**5.0Ah**  
Li-Ion



Ook verkrijgbaar als  
**CE18DSLW4SZ**

EAN 8717574061697

Inclusief HSC II koffer.

Exclusief accu's en lader.

**CE18DSLW4Z**

EAN 4966376302475

In kartonnen doos.

Exclusief HSC II koffer, accu's en lader.

### Standaard toebehoren

2 accu's - 1 oplader - 1 sleutel - 1 voelmaat - 1 HSC II

### Technische specificaties

Capaciteit in staal	1,6 mm
Capaciteit in RVS	1,2 mm
Kleinste radius	25 mm
Aantal slagen belast	18 V - 5.300 /min. 14 V - 5.000 /min.
Lengte	295 mm
Gewicht	2,2 kg
Accu	BSL1850, 18 V, 5.0 Ah
Oplader	UC18YFSL, 220 V, 50/60 Hz



## NR1890DBCLWQZ

Accu spijkerapparaat

EAN 4966376327867

**BRUSH  
LESS**  
Brushless Motor

**5.0Ah**  
Li-Ion



**NEW**

Ook verkrijgbaar als  
**NR1890DBCLW9Z**

EAN 4966376327843

Inclusief HSC IV koffer.

Exclusief accu's en lader.

### Standaard toebehoren

2 accu's - 1 oplader - 1 sleutel - 1 veiligheidsbril - 1 HSC IV

### Technische specificaties

Type spijkers	34° D-kop
Lengte spijkers	50 - 90 mm
Diameter spijkers	2,9 - 3,3 mm
Capaciteit magazijn	47 stuks
Spijkersnelheid	1,5 - 2 sec.
L x B x H	309 x 127 x 342 mm
Gewicht	4,8 kg
Accu	BSL1850, 18 V, 5.0 Ah
Oplader	UC18YFSL, 220 V, 50/60 Hz



### NT1865DBALWXZ

Accu spijkerapparaat  
EAN 8717574061703



Ook verkrijgbaar als  
**NT1865DBALJ4Z**  
EAN 4966376316212  
In kartonnen doos.  
Exclusief HSC IV koffer, accu's en lader.

**Standaard toebehoren**  
2 accu's - 1 oplader - 1 HSC IV

**Technische specificaties**

Type spijkers	15 gauge DA
Lengte spijkers	32 - 65 mm
Diameter spijkers	1,8 mm
Capaciteit magazijn	100 stuks
Spijkersnelheid	3 sec.
L x H	300 x 344 mm
Gewicht	3,5 kg
Accu	BSL1830, 18 V, 3,0 Ah
Oplader	UC18YFSL, 220 V, 50/60 Hz



### NT1865DBSLWXZ

Accu spijkerapparaat  
EAN 4966376316311



Ook verkrijgbaar als  
**NT1865DBSLJ4Z**  
EAN 4966376316274  
In kartonnen doos.  
Exclusief HSC IV koffer, accu's en lader.

**Standaard toebehoren**  
2 accu's - 1 oplader - 1 HSC IV

**Technische specificaties**

Type spijkers	Brads
Lengte spijkers	25 - 65 mm
Diameter spijkers	1,6 mm
Capaciteit magazijn	100 stuks
Spijkersnelheid	3 sec.
L x H	298 x 315 mm
Gewicht	3,4 kg
Accu	BSL1830C, 18 V, 3,0 Ah
Oplader	UC18YFSL, 220 V, 50/60 Hz



### NT1850DBSLWXZ

Accu spijkerapparaat  
EAN 4966376316168



Ook verkrijgbaar als  
**NT1850DBSLJ4Z**  
EAN 4966376316120  
In kartonnen doos.  
Exclusief HSC IV koffer, accu's en lader.

**Standaard toebehoren**  
2 accu's - 1 oplader - 1 HSC IV

**Technische specificaties**

Type spijkers	mini-brads
Lengte spijkers	15 - 50 mm
Diameter spijkers	1,2 mm
Capaciteit magazijn	100 stuks
Spijkersnelheid	3 sec.
L x H	298 x 323 mm
Gewicht	3,3 kg
Accu	BSL1830C, 18 V, 3,0 Ah
Oplader	UC18YFSL, 220 V, 50/60 Hz



**RB18DSLL4Z**

Accu blaas-zuigapparaat  
(18 V)

EAN 4966376317448



**R18DSLW4Z**

Accu stofzuiger  
(18 V)

EAN 4966376317349



**UB18DALE0Z**

Zaklamp  
(14,4 V / 18 V)

EAN 4966376317585



**UB18DELLOZ**

Led zaklamp  
(14,4 V / 18 V)

EAN 4966376317677



**UB18DGLLOZ**

Bouwlamp  
(14,4 V / 18 V)

EAN 4966376317707



**UF18DSALL0Z**

Accu ventilator  
(14,4 V / 18 V)

EAN 4966376319268



**UB18DJLL0Z**

Lamp  
(14,4 V / 18 V)

EAN 4966376317745



Standaard toebehoren  
1 AC adapter

Technische specificaties

Diameter fan	255 mm
Luchtsnelheid hoog	190 m/min.
Luchtsnelheid laag	160 m/min.
Geluidsniveau	52 dB
L x B x H	264 x 370 x 620 mm
Gewicht	3,1 kg



### UR18DSDLW4Z

Radio DAB

EAN 4966376319633



**Standaard toebehoren**

2 AA batterijen - 1 AC adapter

**Technische specificaties**

Beschermingsklasse	IPX4
Frequentiebereik AM	522 - 1629 kHz
Frequentiebereik FM	87,5 - 108 Mhz
Geschatte werkduur	5,5 - 19 hours
Diameter luidsprekers	90 mm
Wattage luidsprekers	2 x 7 W
L x B x H	405 x 312 x 265 mm
Gewicht	4 kg



### UR18DSALW4Z

Radio

EAN 4966376319596



**Standaard toebehoren**

2 AA batterijen - 1 AC adapter

**Technische specificaties**

Beschermingsklasse	IPX4
Frequentiebereik AM	522 - 1629 kHz
Frequentiebereik FM	87,5 - 108 Mhz
Geschatte werkduur	5,5 - 19 hours
Diameter luidsprekers	90 mm
Wattage luidsprekers	2 x 7 W
L x B x H	366 x 303 x 261 mm
Gewicht	3,4 kg



## Slim samengesteld, volledig voorbereid.

Bij HiKOKI kijken we naar welke power tools veel worden gebruikt. Om al jouw werkzaamheden zo makkelijk mogelijk te maken, hebben we combopacks samengesteld met accumachines en HiKOKI System Cases. Zo ben jij als professional volledig én voordelig voorbereid op ieder project.

### Combopack KC18DPLWDZ

Met 2x 5.0 Ah accu's en lader

EAN 4966376326471

#### DS18DBSL

Accu boor-schroefmachine



#### WR18DBDL2

Accu slagmoeraanzetter



#### HSC III koffer



### Combopack KC18DBDLWDZ

Met 2x 5.0 Ah accu's en lader

EAN 4966376326457

#### DS18DBSL

Accu boor-schroefmachine



#### WH18DBDL2

Accu slagschroevendraaier



#### HSC III koffer



### Combopack KC18DRBLWDZ

Met 2x 5.0 Ah accu's en lader

EAN 4966376326495

#### DS18DBSL

Accu boor-schroefmachine



#### DH18DBL

Accu boorhamer



HSC II en  
HSC IV koffer



### Combopack KC18DRBLWBDZ

Met 2x 5.0 Ah accu's en lader

EAN 8717574061710

#### DS18DBSL

Accu boor-schroefmachine



#### DH18DBL

Accu boorhamer met stofafzuigingunit in HSC II



2x HSC II en  
HSC IV koffer



## Combopack KC18DG4LWDZ

Met 3x 5.0 Ah accu's en lader in tas

EAN 4966376326198

### DS18DBSL

Accu boor-schroefmachine



**BRUSH  
LESS**  
Brushless Motor



### WR18DBDL2

Accu slagmoeraanzetter



**BRUSH  
LESS**  
Brushless Motor  
**IP56**



### DH18DBL

Accu boorhamer



**BRUSH  
LESS**  
Brushless Motor  
**RFC**  
REVERSE FORCE CONTROL



### G18DBL

Accu haakse slijpmachine



**BRUSH  
LESS**  
Brushless Motor

## Combopack KC10DMLWBZ

Met 2x 1.5 Ah accu's en lader in tas

EAN 4966376315208

### DS10DAL

Accu boor-schroefmachine



**TEV  
PEAK**



### WH10DAL

Accu slagschroevendraaier



**TEV  
PEAK**



### DS10DALWPZ

Accu boor-schroefmachine

EAN 4966376309009



#### Standaard toebehoren

2 accu's - 1 oplader - 1 kruiskopbit nr. 2 - 1 HSC I

#### Technische specificaties



Capaciteit in hout	29 mm
Capaciteit in staal	10 mm
Houtschroeven	5,8 x 45 mm
Machineschroeven	6 mm
Max. aandraaimoment hard	36 Nm
Capaciteit boorhouder	10 mm
L x B x H	170 x 60 x 210 mm
Gewicht	1 kg
Accu	BCL1015, 10,8 V, 1,5 Ah
Oplader	UC10SL2, 220V, 50/60 Hz

### DS10DALWCZ

Accu boor-schroefmachine

EAN 4966376308965



#### Standaard toebehoren

2 accu's - 1 oplader - 1 kruiskopbit nr. 2 - 1 kunststof koffer

#### Technische specificaties



Capaciteit in hout	29 mm
Capaciteit in staal	10 mm
Houtschroeven	5,8 x 45 mm
Machineschroeven	6 mm
Max. aandraaimoment hard	36 Nm
Toerental onbelast hoog	0 - 1.300 tr/min.
Toerental onbelast laag	0 - 350 tr/min.
Capaciteit boorhouder	10 mm
L x B x H	170 x 60 x 210 mm
Gewicht	1 kg
Accu	BCL1015, 10,8 V, 1,5 Ah
Oplader	UC10SL2, 220V, 50/60 Hz

### WH10DALWCZ

Accu slagschroevendraaier

EAN 4966376320035



#### Standaard toebehoren

2 accu's - 1 oplader - 1 kruiskopbit nr. 2 - 1 kunststof koffer



#### Technische specificaties

Houtschroeven	4 - 8 mm
Bouten en moeren	M5 - M10
Max. aandraaimoment	108 Nm
Aantal slagen belast	0 - 3.200 /min.
Toerental onbelast	0 - 2.700 tr/min.
L x B x H	151 x 58 x 209 mm
Gewicht	1 kg
Accu	BCL1015, 10,8 V, 1,5 Ah
Oplader	UC10SL2, 220V, 50/60 Hz

## WM10DBLUGZ

### Accu elektronische pulse slagschroevendraaier

EAN 4966376321735



#### Standaard toebehoren

2 accu's - 1 oplader - 1 kunststof koffer

#### Technische specificaties

Capaciteit in hout	20 mm
Capaciteit in metaal	5 mm
Capaciteit in steen	6 mm
Houtschroeven	3,8 x 50 mm
Bouten en moeren	M4 - M8
Zelfborende schroeven	3,5 - 5 mm
Schroeven	M6 mm

#### Aandraaimoment

Elektronische pulse stand	19 Nm
Montagestand	20 Nm
Zelfborende stand	14 Nm
Boorstand	1,6 Nm
Slipkoppeling	6 Nm

#### Toerental onbelast

Elektronische pulse stand	0 - 2.200 tr/min.
Montagestand	0 - 1.300 tr/min.
Zelfborende schroef stand	0 - 2.200 tr/min.
Boorstand	0 - 2.200 tr/min.
Elektronische slipkoppeling	0 - 1.140 tr/min.

#### Aantal slagen belast

Elektronische pulse stand	0 - 1.090 /min.
Montagestand	0 - 1.030 /min.
Zelfborende schroef stand	0 - 1.090 /min.

Gereedschapsopname

1/4" zeskant

Geluidsniveau

67 dB

L x H

139 x 216 mm

Gewicht

1 kg

Accu

BCL1015, 10,8 V, 1,5 Ah

Oplader

UC105FL, 220 V, 50/60 Hz

#### Ook verkrijgbaar als

**WM10DBLRLZ**

EAN 4966376321711

In kartonnen doos.

Exclusief kunststof koffer, accu's en lader.



## WH10DCLWCZ

### Accu haakse slagschroevendraaier

EAN 4966376320141



#### Ook verkrijgbaar als

**WH10DCLW4Z**

EAN 4966376320134

In kartonnen doos.

Exclusief kunststof koffer, accu's en lader.

#### Standaard toebehoren

2 accu's - 1 oplader - 1 kunststof koffer

#### Technische specificaties

Houtschroeven	4 - 8 mm
Bouten en moeren	M4 - M10
Max. aandraaimoment	30 Nm
Aantal slagen belast	0 - 3.000 /min.
Toerental onbelast	0 - 2.100 tr/min.
L x H	280 x 53 mm
Gewicht	1 kg
Accu	BCL1015, 10,8 V, 1,5 Ah
Oplader	UC105FL, 220 V, 50/60 Hz

### GP10DLUCZ

Accu stift slijpmachine

EAN 4966376315130



#### Standaard toebehoren

1 accu - 1 oplader - 40-delige accessoireset - 1 kunststof koffer



#### Technische specificaties

Slijpstiften	3,2 mm
Toerental onbelast	5.000 - 35.000 tr/min.
Lengte	208 mm
Gewicht	0,48 kg
Accu	BCL1015
Oplader	UC10SL, 220V, 50/60 Hz

### CR10DLWCZ

Accu reciprozaag

EAN 4966376304615



#### Standaard toebehoren

2 accu's - 1 oplader - 10 zaagbladen - 1 inbus sleutel 3 mm  
1 kunststof koffer



#### Technische specificaties

Capaciteit in hout	50 mm
Capaciteit in staal	4 mm
Max. diam. ronde stalen buis	45 mm
Toerental onbelast	0 - 2.100 tr/min.
Slaglengte	13 mm
Lengte	349 mm
Gewicht	1,2 kg
Accu	BCL1015, 10,8 V, 1,5 Ah
Oplader	UC10SFL, 220 V, 50/60 Hz

### DB3DL2WCZ

Accu schroefmachine

EAN 4966376306206



#### Standaard toebehoren

2 accu's - 1 oplader - 1 kruiskopbit nr. 2 - 1 kunststof koffer



#### Technische specificaties

Capaciteit in staal	5 mm
Hout Schroeven	3,8 x 38 mm
Machineschroeven	5 mm
Aandraaimoment	0,3 - 2,9 Nm
Max. aandraaimoment	5 Nm
Toerental onbelast hoog	600 tr/min.
Toerental onbelast laag	200 tr/min.
L x H	268 x 134 mm
Gewicht	0,4 kg
Accu	EBM315, 3,6 V, 1,5 Ah
Oplader	UC3SFL

MULTI VOLT battery



# AC power. DC freedom.

**NEW**



**36V 18V Li-ion**

- ▶ 1.080 W high power output
- ▶ Compact & lightweight
- ▶ Automatic voltage change between 36 V and 18 V

Een compleet nieuwe generatie accusystemen, die van de buitenkant oogt als een 18 V accu, maar van binnen is voorzien van de laatste technologieën. Innovaties om jouw prestaties te verbeteren. Zo zorgt het dubbele voltage voor optimale kracht, en dat zelfs draadloos. De li-ion accu's van 36 V zijn uitwisselbaar met de 18 V machines. Kortom, met slechts een simpele klik behaal jij de maximale prestatie.

# MULTI VOLT. Compatible met bestaande 18 V power tools.

De MULTI VOLT accu is volledig uitwisselbaar met zowel 36 V als bijna alle huidige snoerloze 18 V power tools. Afhankelijk van de power tool die je gebruikt, verandert de accu automatisch tussen twee voltages: 36 V met 2.5 Ah en 18 V met 5.0 Ah.

Alle power tools op deze pagina's kunnen gebruikt worden met de MULTI VOLT accu. Je klikt de accu simpelweg op de power tool die je nodig hebt en je bent meteen klaar voor de maximale prestatie.

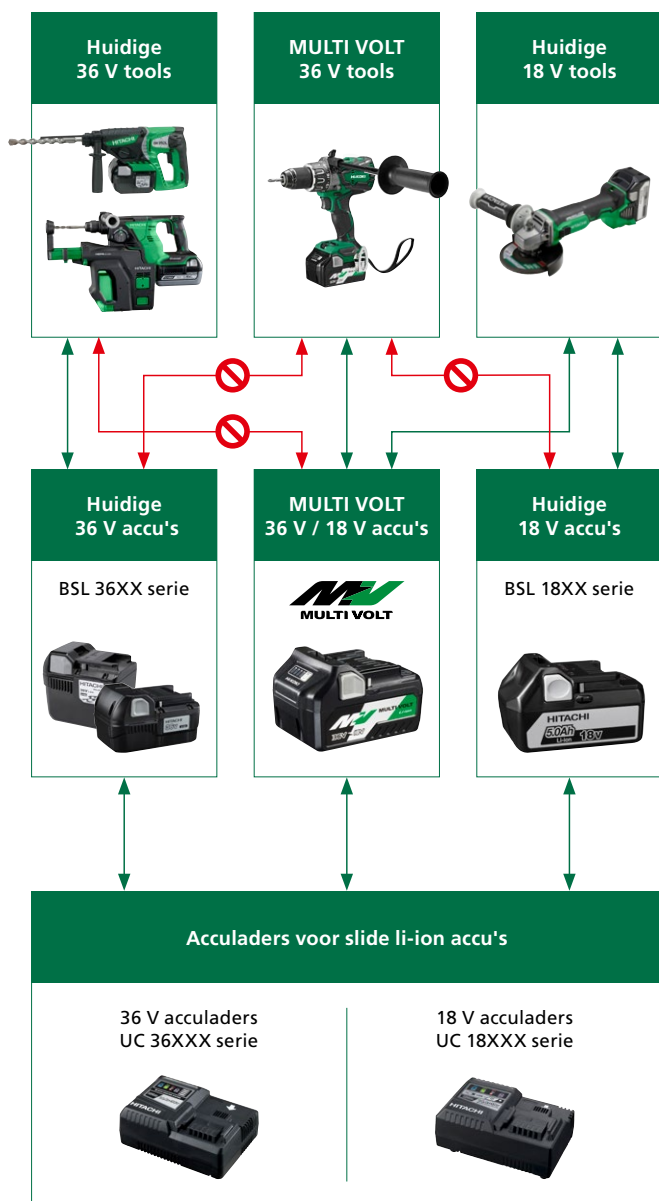

**371750**  
Accu BSL36A18  
EAN 4549115156203



Technische specificaties  
Accu (BSL36A18) 18 V - 36 V, 5.0 Ah - 2.5 Ah

**373788**  
Twin pack BSL36A18  
EAN 4549115188488























Technische specificaties  
Accu (BSL36A18) 18 V - 36 V, 5.0 Ah - 2.5 Ah

**UC18YSL3WEZ**  
Booster pack 2  
EAN 4966376328604



Technische specificaties  
Accu (BSL36A18) 18 V - 36 V, 5.0 Ah - 2.5 Ah  
Oplader UC18YSL3

# Accu machines Li-ion accu's en laders

Li-ion accu's						Type		
Voltage	Afb.	Type	Soort	Capaciteit	Bestelnr.	UC3SFLW0Z	UC3SMLW0Z	UC7SL
3,6 V		EBM315L	blok	1.5 Ah	326299	30 min.	60 min.	
7,2 V		BCL715	blok	1.5 Ah	335684			30 min.
10,8 V		BCL1015	blok	1.5 Ah	331067			
14,4 V		BCL1415	blok	1.5 Ah	327729			
14,4 V		BSL1415X	slide	1.5 Ah	330558			
14,4 V		BSL1425	slide	2.5 Ah	335784			
14,4 V		BSL1430C	slide	3.0 Ah	339780			
14,4 V		BSL1450	slide	5.0 Ah	335786			
14,4 V		BSL1460	slide	6.0 Ah	338887			
18 V		BCL1815	blok	1.5 Ah	327731			
18 V		BSL1815X	slide	1.5 Ah	330557			
18 V		BSL1825	slide	2.5 Ah	335788			
18 V		BSL1830C	slide	3.0 Ah	339783			
18 V		BSL1850	slide	5.0 Ah	335790			
18 V		BSL1860	slide	6.0 Ah	338891			
25 V		BSL2530	slide	3.0 Ah	328033			
36 V		BSL3620	slide	2.0 Ah	334998			
36 V		BSL3626	slide	2.6 Ah	328036			
36 V		BSL3626X	slide	2.6 Ah	339975			
36 V		BSL3660	slide	6.0 Ah	339973			

## Accu machines Li-ion accu's en laders



UC10SL2W0Z



UC18YGL2W0Z



UC18YKSLW0Z



UC18YRLW0Z



UC18YSL3W0Z



UC18YFSLW0Z











UC18YML2W0Z



UC36YSLW0Z

30 min.							
	40 min.		20 min.				
		40 min.		15 min.	22 min.	22/60 min.	15 min.
		75 min.		25 min.	35 min.	35/100 min.	25 min.
		90 min.		30 min.	45 min.	45/120 min.	30 min.
		150 min.		32 min.	75 min.	75/200 min.	50 min.
		180 min.		38 min.	90 min.	90/240 min.	60 min.
	40 min.		20 min.				
		40 min.		15 min.	22 min.	22/60 min.	15 min.
		75 min.		25 min.	35 min.	35/100 min.	25 min.
		90 min.		30 min.	45 min.	45/120 min.	30 min.
		150 min.		32 min.	75 min.	75/200 min.	50 min.
		180 min.		38 min.	90 min.	90/240 min.	60 min.
							30 min.
							20 min.
							22 min.
							25 min.
							60 min.

# Accu machines Ni-MH accu's en laders / Ni-CAD accu's en laders

						Laders	
Ni-MH accu's						Type	
							
						UC18YG 0Z	UC18YRLW0Z
Voltage	Afbeelding	Type	Soort	Capaciteit	Bestelnr.		
9,6 V		EB930H	blok	3.0 Ah	318368	90 min.	45 min.
18 V		EB1826HL	blok	2.6 Ah	322878	80 min.	40 min.
18 V		EB1830H	blok	3.0 Ah	319765	90 min.	45 min.
24 V		EB2430H	blok	3.0 Ah	319105		
Ni-CAD accu's							
Voltage	Afbeelding	Type	Soort	Capaciteit	Bestelnr.		
12 V		BCC1215	blok	1.5 Ah	333156	40 min.	20 min.
14,4 V		BCC1415	blok	1.5 Ah	333159	40 min.	20 min.
18 V		BCC1815	blok	1.5 Ah	333161	40 min.	20 min.



# Klop-boor- schroefmachines



## D13VGWUZ

Boormachine









EAN 4966376271016



### Standaard toebehoren

1 zijhandgreep - 1 kunststof koffer

### Technische specificaties

	Capaciteit in hout	40 mm
	Capaciteit in staal	13 mm
	Max. aandraaimoment	80 Nm
	Opname spindel	1/2"
	Opgenomen vermogen	710 W
	Toerental onbelast	0 - 600 tr/min.
	Capaciteit boorhouder	1,5 - 13 mm
	Lengte	287 mm
	Gewicht	2,1 kg

## D13VFWUZ

Boormachine









EAN 4966376270910



### Standaard toebehoren

1 zijhandgreep - 1 kunststof koffer

### Technische specificaties

	Capaciteit in hout	40 mm
	Capaciteit in staal	13 mm
	Max. aandraaimoment	50 Nm
	Opname spindel	1/2"
	Opgenomen vermogen	710 W
	Toerental onbelast	0 - 950 tr/min.
	Capaciteit boorhouder	1,5 - 13 mm
	Lengte	287 mm
	Gewicht	2,1 kg

## D10VGWUZ

Boormachine









EAN 4966376270248



### Standaard toebehoren

1 kunststof koffer

### Technische specificaties

	Capaciteit in hout	29 mm
	Capaciteit in staal	10 mm
	Max. aandraaimoment hard	40 Nm
	Opname spindel	1/2"
	Opgenomen vermogen	710 W
	Toerental onbelast hoog	0 - 3.300 tr/min.
	Toerental onbelast laag	0 - 1.200 tr/min.
	Capaciteit boorhouder	0,8 - 10 mm
	L x B x H	263 mm
	Gewicht	1,8 kg

## D10VFWUZ

Boormachine

EAN 4966376270163



**Standaard toebehoren**  
1 kunststof koffer

**Technische specificaties**

Capaciteit in hout	29 mm
Capaciteit in staal	10 mm
Max. aandraaimoment	17 Nm
Opname spindel	1/2"
Opgenomen vermogen	710 W
Toerental onbelast	0 - 3.000 tr/min.
Capaciteit boorhouder	0,8 - 10 mm
Geluidsniveau	78 dB
Lengte	263 mm
Gewicht	1,8 kg



## D6SHUAZ

Boormachine

EAN 4966376271498



**Standaard toebehoren**

1 diepteaanslag - 1 draagbeugel - 1 boorkopsleutel

**Technische specificaties**

Capaciteit in hout	9 mm
Capaciteit in staal	6,5 mm
Max. aandraaimoment	3,6 Nm
Opname spindel	1/2"
Opgenomen vermogen	240 W
Toerental onbelast	4.500 tr/min.
Capaciteit boorhouder	0,8 - 6,5 mm
L x B x H	206 x 148 x 60 mm
Gewicht	0,9 kg



## D13VLWDZ

Boor-schroefmachine

EAN 4966376271290

**FHB**  
FLUOROPOLYMER BOOR



**Standaard toebehoren**

1 diepteaanslag - 1 zijhandgreep

**Technische specificaties**

Capaciteit in hout	40 mm
Capaciteit in staal	13 mm
Max. aandraaimoment hoog	24,5 Nm
Max. aandraaimoment laag	66,3 Nm
Opname spindel	1/2"
Opgenomen vermogen	860 W
Toerental onbelast hoog	0 - 3.000 tr/min.
Toerental onbelast laag	0 - 1.100 tr/min.
Capaciteit boorhouder	13 mm
Geluidsniveau	84 dB
Lengte	363 mm
Gewicht	3 kg



## D13VB3LBZ

Boor-schroefmachine

EAN 4966376270804



**Standaard toebehoren**  
1 handgreep - 1 diepteanslag

**Technische specificaties**

Capaciteit in hout	40 mm
Capaciteit in staal	13 mm
Max. aandraaimoment hoog	11 Nm
Max. aandraaimoment laag	30,4 Nm
Opname spindel	1/2"
Opgenomen vermogen	790 W
Toerental onbelast hoog	0 - 3.000 tr/min.
Toerental onbelast laag	0 - 1.000 tr/min.
Capaciteit boorhouder	13 mm
Geluidsniveau	79 dB
L x H	339 x 193 mm
Gewicht	2 kg



## D13WAZ

Boor-schroefmachine

EAN 4966376270743



**Standaard toebehoren**  
1 boorkopsleutel - 1 handgreep

**Technische specificaties**

Capaciteit in hout	40 mm
Capaciteit in staal	13 mm
Max. aandraaimoment	55 Nm
Opname spindel	1/2"
Opgenomen vermogen	720 W
Toerental onbelast	550 tr/min.
Capaciteit boorhouder	1,2 - 13 mm
Gewicht	3 kg



## D10VC3WCZ

Boor-schroefmachine

EAN 4966376270118



**Technische specificaties**

Capaciteit in hout	32 mm
Capaciteit in staal	10 mm
Max. aandraaimoment	12,8 Nm
Opgenomen vermogen	600 W
Toerental onbelast	0 - 2.500 tr/min.
Capaciteit boorhouder	10 mm
Lengte	242 mm
Vibratieniveau	3,2 (Tri-axial) m/sec <sup>2</sup> .
Vibration uncertainty	1,5 (K) m/sec <sup>2</sup> .
Gewicht	1,4 kg



## DV22VW4Z

Klop-boor-schroefmachine

EAN 4966376287666

**FHB**  
ALUMINIUM HOUSING BODY



### Standaard toebehoren

1 handgreep - 1 diepteanslag - 1 HSC I

### Technische specificaties

Capaciteit in hout	40 mm
Capaciteit in staal	16 mm
Capaciteit in steen	22 mm
Max. aandraaimoment hoog	27,5 Nm
Max. aandraaimoment laag	74,3 Nm
Opname spindel	1/2"
Opgenomen vermogen	1.120 W
Toerental onbelast hoog	0 - 3.000 tr/min.
Toerental onbelast laag	0 - 1.000 tr/min.
Aantal slagen onbelast hoog	0 - 39.000 /min.
Aantal slagen onbelast laag	0 - 13.000 /min.
Vibratieniveau	19,5 (Tri-axial) m/sec <sup>2</sup> .
Geluidsniveau	84 dB
Lengte	363 mm
Gewicht	3 kg



## DV20VDW4Z

Klop-boor-schroefmachine

EAN 4966376287536

**FHB**  
ALUMINIUM HOUSING BODY



### Standaard toebehoren

1 handgreep - 1 diepteanslag - 1 HSC I

### Technische specificaties

Capaciteit in hout	40 mm
Capaciteit in staal	13 mm
Capaciteit in steen	20 mm
Max. aandraaimoment hoog	24,5 Nm
Max. aandraaimoment laag	66,3 Nm
Opname spindel	1/2"
Opgenomen vermogen	860 W
Toerental onbelast hoog	0 - 3.000 tr/min.
Toerental onbelast laag	0 - 1.000 tr/min.
Aantal slagen onbelast hoog	0 - 39.000 /min.
Aantal slagen onbelast laag	0 - 13.000 /min.
Capaciteit boorhouder	13 mm
Vibratieniveau	16,6 (Tri-axial) m/sec <sup>2</sup> .
Geluidsniveau	84 dB
Lengte	363 mm
Gewicht	3 kg



## DM20VWVZ

Klop-boor-schroefmachine

EAN 4966376285433

**UVP**  
LOCK WORKTOP PROTECTION



### Standaard toebehoren

1 handgreep - 1 diepteanslag - 1 kunststof koffer

### Technische specificaties

Capaciteit in hout	40 mm
Capaciteit in staal	13 mm
Capaciteit in steen	20 mm
Max. aandraaimoment hoog	20,9 Nm
Max. aandraaimoment laag	49,3 Nm
Opname spindel	1/2"
Opgenomen vermogen	790 W
Toerental onbelast hoog	0 - 3.300 tr/min.
Toerental onbelast laag	0 - 1.300 tr/min.
Aantal slagen onbelast hoog	0 - 27.000 /min.
Aantal slagen onbelast laag	0 - 9.000 /min.
Capaciteit boorhouder	13 mm
Geluidsniveau	78 dB
Lengte	390 mm
Gewicht	2,5 kg



## DV20VB2WVZ

Klop-boor-schroefmachine

EAN 4966376287406



### Standaard toebehoren

1 handgreep - 1 diepteanslag - 1 kunststof koffer

### Technische specificaties

Capaciteit in hout	40 mm
Capaciteit in staal	13 mm
Capaciteit in steen	20 mm
Max. aandraaimoment hoog	10,9 Nm
Max. aandraaimoment laag	29,5 Nm
Opname spindel	1/2"
Opgenomen vermogen	790 W
Toerental onbelast hoog	0 - 3.000 tr/min.
Toerental onbelast laag	0 - 1.000 tr/min.
Aantal slagen onbelast hoog	0 - 39.000 /min.
Aantal slagen onbelast laag	0 - 13.000 /min.
Capaciteit boorhouder	13 mm
Lengte	333 mm
Gewicht	2,2 kg



## DV20VB2WUZ

Klop-boor-schroefmachine

EAN 4966376287390



### Standaard toebehoren

1 handgreep - 1 diepteanslag - 1 kunststof koffer

### Technische specificaties

Capaciteit in hout	40 mm
Capaciteit in staal	13 mm
Capaciteit in steen	20 mm
Max. aandraaimoment hoog	19,6 Nm
Max. aandraaimoment laag	54,1 Nm
Opname spindel	1/2"
Toerental onbelast hoog	0 - 3.000 tr/min.
Toerental onbelast laag	0 - 1.000 tr/min.
Aantal slagen onbelast hoog	0 - 39.000 /min.
Aantal slagen onbelast laag	0 - 13.000 /min.
Capaciteit boorhouder	13 mm
Geluidsniveau	79 dB
Lengte	333 mm
Gewicht	2,2 kg



## DV20VB2WSZ

Klop-boor-schroefmachine

EAN 4966376287376



### Standaard toebehoren

1 handgreep - 1 diepteanslag - 1 boorkopsleutel  
1 kunststof koffer

### Technische specificaties

Capaciteit in hout	40 mm
Capaciteit in staal	13 mm
Capaciteit in steen	20mm
Max. aandraaimoment hoog	19,6 Nm
Max. aandraaimoment laag	54,1 Nm
Opname spindel	1/2"
Opgenomen vermogen	790 W
Toerental onbelast hoog	0 - 3.000 tr/min.
Toerental onbelast laag	0 - 1.000 tr/min.
Aantal slagen onbelast hoog	0 - 39.000 /min.
Aantal slagen onbelast laag	0 - 13.000 /min.
Capaciteit boorhouder	13 mm
Geluidsniveau	79 dB
Lengte	333 mm
Gewicht	2,2 kg



## DV18VWUZ

Klop-boor-schroefmachine

EAN 4966376287185



### Standaard toebehoren

1 handgreep - 1 diepteanslag - 1 kunststof koffer

### Technische specificaties

Capaciteit in hout	30 mm
Capaciteit in staal	13 mm
Capaciteit in steen	18 mm
Opname spindel	1/2"
Opgenomen vermogen	690 W
Toerental onbelast hoog	0 - 3.000 tr/min.
Toerental onbelast laag	0 - 1.000 tr/min.
Aantal slagen belast hoog	0 - 27.300 /min.
Capaciteit boorhouder	1,5 - 13 mm
Lengte	333 mm
Gewicht	2 kg



## DV16VWUZ

Klop-boor-schroefmachine

EAN 4966376286416



### Standaard toebehoren

1 handgreep - 1 diepteanslag - 1 kunststof koffer

### Technische specificaties

Capaciteit in hout	25 mm
Capaciteit in staal	13 mm
Capaciteit in steen	16 mm
Max. aandraaimoment	12,6 Nm
Opname spindel	1/2"
Opgenomen vermogen	590 W
Toerental onbelast	0 - 2.900 tr/min.
Aantal slagen onbelast	0 - 46.400 /min.
Capaciteit boorhouder	13 mm
Geluidsniveau	78 dB
Lengte	269 mm
Gewicht	1,5 kg



## FDV16VB2U3Z

Klop-boor-schroefmachine

EAN 4966376298440



### Standaard toebehoren

1 handgreep - 1 diepteanslag - 1 kunststof koffer

### Technische specificaties

Capaciteit in hout	25 mm
Capaciteit in staal	13 mm
Capaciteit in steen	16 mm
Max. aandraaimoment	9,6 Nm
Opname spindel	1/2"
Opgenomen vermogen	550 W
Toerental onbelast	0 - 2.900 tr/min.
Aantal slagen onbelast	0 - 46.400 /min.
Capaciteit boorhouder	1,5 - 13 mm
Geluidsniveau	80 dB
L x B x H	259 x 67 x 198 mm
Gewicht	1,5 kg



## D10YBM1Z

Haakse boormachine

EAN 4966376270590



### Standaard toebehoren

1 boorkopsleutel - 1 zijhandgreep

### Technische specificaties

Capaciteit in hout	22 mm
Capaciteit in staal	10 mm
Opname spindel	3/8"
Opgenomen vermogen	500 W
Toerental onbelast	500 - 2.300 tr/min.
Aandraaimoment	12 Nm
Hoogte van tandwielkast met boorhouder	83 mm
Hoekmaat	22,5 mm
Capaciteit boorhouder	1,5 - 10 mm
L x B x H	290 x 74 x 83 mm
Gewicht	1,5 kg

## W8VB2WFZ

Schroevendraaier

EAN 4966376280889



### Standaard toebehoren

1 magnetische bithouder - 1 diepteanslag - 1 haak

### Technische specificaties

Houtschroeven	6,2 x 50 mm
Zelfborende schroeven	8 mm
Gipsplaatschroeven	6 mm
Max. aandraaimoment	23 Nm
Opgenomen vermogen	620 W
Toerental onbelast	0 - 1.700 tr/min.
Geluidsniveau	76 dB
Lengte	321 mm
Gewicht	1,5 kg

## W6VA4WAZ

Schroevendraaier

EAN 4966376280612



### Standaard toebehoren

1 magnetische bithouder - 1 philips-bit nr. 2  
1 diepteanslag - 1 haak

### Technische specificaties

Houtschroeven	6 mm
Zelfborende schroeven	6 mm
Gipsplaatschroeven	6 mm
Max. aandraaimoment	12 Nm
Opgenomen vermogen	620 W
Toerental onbelast	0 - 3.000 tr/min.
Geluidsniveau	76 dB
Lengte	328 mm
Gewicht	1,4 kg



## W6V4LAZ

Schroevendraaier

EAN 4966376280452



### Standaard toebehoren

1 magnetische bithouder - 1 philips-bit nr. 2  
1 diepteaanslag - 1 haak



### Technische specificaties

Houtschroeven	6 mm
Zelfborende schroeven	6 mm
Gipsplaatschroeven	6 mm
Max. aandraaimoment	9 Nm
Opgenomen vermogen	620 W
Toerental onbelast	0 - 4.500 tr/min.
Geluidsniveau	76 dB
Lengte	328 mm
Gewicht	1,4 kg

## W6VMWAZ

Schroevendraaier

EAN 4966376280780



### Standaard toebehoren

1 magnetische bithouder - 1 diepteaanslag  
1 philips-bit nr. 2 - 1 haak



### Technische specificaties

Zelfborende schroeven	6 mm
Gipsplaatschroeven	6 mm
Max. aandraaimoment	9 Nm
Opgenomen vermogen	620 W
Toerental onbelast	0 - 6.000 tr/min.
Geluidsniveau	76 dB
Lengte	328 mm
Gewicht	1,4 kg

## W6VB3WFZ

Schroevendraaier

EAN 4966376280711



### Standaard toebehoren

1 magnetische bithouder - 1 diepteanslag - 1 haak



### Technische specificaties

Houtschroeven	5,8 x 50 mm
Zelfborende schroeven	6 mm
Gipsplaatschroeven	6 mm
Max. aandraaimoment	18 Nm
Opgenomen vermogen	620 W
Toerental onbelast	0 - 2.600 tr/min.
Geluidsniveau	76 dB
Lengte	321 mm
Gewicht	1,5 kg

## W4YDLAZ

Schroefautomaat

EAN 4966376280339



### Standaard toebehoren

1 philips-bit nr. 2 - 1 haak - 1 kunststof koffer



### Technische specificaties

Houtschroeven	4 x 25 - 41 mm
Gipsplaatschroeven	3,6 - 3,9 x 25 - 35 mm
Toerental onbelast	0 - 4.700 tr/min.
Geluidsniveau	81 dB
L x B x H	335 x 78 x 198 mm
Gewicht	1,7 kg

# Slagmoeraanzetters



# Slagmoeraanzetters

## WR25SEWAZ

Slagmoeraanzetter

EAN 4966376290307



### Standaard toebehoren

1 zijhandgreep compleet - 1 kunststof koffer



### Technische specificaties

Bouten en moeren	M22 - M30
Max. aandraaimoment	1.000 Nm
Opgenomen vermogen	900 W
Toerental onbelast	1.100 tr/min.
Aantal slagen belast	1.500 /min.
Gereedschapsopname	1" vierkant
L x H	340 x 293 mm
Gewicht	7,7 kg



## WR22SEWAZ

Slagmoeraanzetter

EAN 4966376290116



### Standaard toebehoren

1 zijhandgreep compleet - 1 kunststof koffer



### Technische specificaties

Bouten en moeren	M14 - M24
Max. aandraaimoment	620 Nm
Opgenomen vermogen	800 W
Toerental onbelast	1.400 tr/min.
Aantal slagen belast	2.000 /min.
Gereedschapsopname	3/4" vierkant
L x H	280 x 261 mm
Gewicht	4,6 kg



## WR16SEWAZ

Slagmoeraanzetter

EAN 4966376289912



### Technische specificaties

Bouten en moeren	M12 - M22
Max. aandraaimoment	360 Nm
Opgenomen vermogen	370 W
Toerental onbelast hoog	1.600 tr/min.
Toerental onbelast laag	1.100 tr/min.
Aantal slagen belast hoog	1.900 /min.
Gereedschapsopname	1/2" vierkant
L x H	228 x 260 mm
Gewicht	2,5 kg



## WR14VEWAZ

Slagmoeraanzetter

EAN 4966376289738

**BRUSH**  
**LESS**  
Brushless Motor



### Technische specificaties

Bouten en moeren	M10 - M20
Max. aandraaimoment	250 Nm
Opgenomen vermogen	370 W
Toerental onbelast hoog	0 - 2.100 tr/min.
Toerental onbelast laag	0 - 1.400 tr/min.
Aantal slagen belast hoog	0 - 2.700 /min.
Gereedschapsopname	1/2" vierkant
L x H	210 x 240 mm
Gewicht	2 kg





## Mixers



### UM16VSTLAZ

Mixer

EAN 4966376280278



**Standaard toebehoren**  
1 mixgarde 160 mm

**Technische specificaties**

Capaciteit mixerstaaf	160 mm
Opgenomen vermogen	1.500 W
Toerental onbelast hoog	300 - 650 tr/min.
Toerental onbelast laag	150 - 300 tr/min.
Gereedschapsopname	M14
Lengte	335 mm
Gewicht	5,6 kg



### UM12VSTLAZ

Mixer

EAN 4966376280209



**Standaard toebehoren**  
1 mixgarde 120 mm

**Technische specificaties**

Capaciteit mixerstaaf	120 mm
Opgenomen vermogen	1.100 W
Toerental onbelast hoog	300 - 650 tr/min.
Toerental onbelast laag	150 - 300 tr/min.
Gereedschapsopname	M14
Lengte	325 mm
Gewicht	5,4 kg



# Hamers





## DH28PBYWSZ

SDS-PLUS Boorhamer

EAN 4966376283873



### Standaard toebehoren

1 handgreep - 1 diepteanslag - 1 kunststof koffer

### Technische specificaties

Capaciteit in hout	32 mm
Capaciteit in staal	13 mm
Capaciteit in beton	28 mm
Opgenomen vermogen	850 W
Slagenergie	3 J
Toerental onbelast	0 - 1.100 tr/min.
Aantal slagen belast	0 - 4.300 /min.
Vibratieniveau	11,5 (Tri-axial) m/sec <sup>2</sup> .
Vibratie onzekerheidsfactor	1,5 (K) m/sec <sup>2</sup> .
Geluidsniveau	100 dB
Geluidsdruk niveau	89 dB Lpa
Geluid onzekerheidsfactor	3 (K) dB
L x B x H	367 x 80 x 198 mm
Gewicht	2,9 kg



## DH26PBWSZ

SDS-PLUS Boorhamer

EAN 4966376283330



### Standaard toebehoren

1 handgreep - 1 diepteanslag - 1 kunststof koffer

### Technische specificaties

Capaciteit in hout	32 mm
Capaciteit in staal	13 mm
Capaciteit in beton	26 mm
Kroonboren	50 mm
Opgenomen vermogen	830 W
Slagenergie	2,7 J
Toerental onbelast	0 - 1.100 tr/min.
Aantal slagen belast	0 - 4.300 /min.
L x B x H	367 x 80 x 198 mm
Gewicht	2,8 kg



## DH26PBW1Z

SDS-PLUS Boorhamer

EAN 4966376283323



### Standaard toebehoren

1 handgreep - 1 diepteanslag - 1 HSC I

### Technische specificaties

Capaciteit in hout	32 mm
Capaciteit in staal	13 mm
Capaciteit in beton	26 mm
Kroonboren	50 mm
Opgenomen vermogen	830 W
Slagenergie	2,7 J
Toerental onbelast	0 - 1.100 tr/min.
Aantal slagen belast	0 - 4.300 /min.
L x B x H	367 x 80 x 198 mm
Gewicht	2,8 kg







## DH24PGWSZ

SDS-PLUS Boorhamer

EAN 4966376282845















	<b>Standaard toebehoren</b>	
	1 handgreep - 1 diepteanslag - 1 kunststof koffer	
	<b>Technische specificaties</b>	
	Capaciteit in hout	32 mm
	Capaciteit in staal	13 mm
	Capaciteit in beton	24 mm
	Kroonboren	25 - 50 mm
	Opgenomen vermogen	730 W
	Slagenergie	2,7 J
	Toerental onbelast	0 - 1.150 tr/min.
	Aantal slagen belast	0 - 3.950 /min.
	L x B x H	367 x 80 x 198 mm
	Gewicht	2,7 kg

## DH30PC2WSZ

SDS-PLUS Boor-hakhamer

EAN 4966376284498





	<b>Standaard toebehoren</b>	
	1 handgreep - 1 diepteanslag - 1 kunststof koffer	
	<b>Technische specificaties</b>	
	Capaciteit in hout	32 mm
	Capaciteit in staal	13 mm
	Capaciteit in beton	30 mm
	Kroonboren	90 mm
	Opgenomen vermogen	850 W
	Slagenergie	3,2 J
	Toerental onbelast	0 - 850 tr/min.
	Aantal slagen belast	0 - 3.700 /min.
	Geluidsniveau	88 dB
	L x B x H	355 x 102 x 227 mm
	Gewicht	4,3 kg

## DH28PDWSZ

SDS-PLUS Boor-hakhamer

EAN 4966376284283



	<b>Standaard toebehoren</b>	
	1 handgreep - 1 diepteanslag - 1 kunststof koffer	
	<b>Technische specificaties</b>	
	Capaciteit in hout	32 mm
	Capaciteit in staal	13 mm
	Capaciteit in beton	28 mm
	Kroonboren	80 mm
	Opgenomen vermogen	720 W
	Slagenergie	3,2 J
	Toerental onbelast	0 - 800 tr/min.
	Aantal slagen belast	0 - 4.000 /min.
	Vibratieniveau	16,8 (Tri-axial) m/sec <sup>2</sup> .
	Geluidsniveau	81,8 dB
	L x B x H	458 x 112 x 225 mm
	Gewicht	4,3 kg

### DH28PCWSZ

SDS-PLUS Boor-hakhamer

EAN 4966376283996



**Standaard toebehoren**

1 handgreep - 1 diepteanslag - 1 kunststof koffer



**Technische specificaties**

Capaciteit in hout	32 mm
Capaciteit in staal	13 mm
Capaciteit in beton	28 mm
Kroonboren	80 mm
Opgenomen vermogen	720 W
Slagenergie	3,2 J
Toerental onbelast	0 - 800 tr/min.
Aantal slagen belast	0 - 4.000 /min.
Vibratieniveau	16,8 (Tri-axial) m/sec <sup>2</sup> .
Geluidsniveau	81,8 dB
L x B x H	316 x 102 x 208 mm
Gewicht	3,4 kg

### DH28PMYWSZ

SDS-PLUS Boor-hakhamer met verwisselbare boorhouder

EAN 4966376284344



**Standaard toebehoren**

1 handgreep - 1 diepteanslag - 1 kunststof koffer



**Technische specificaties**

Capaciteit in hout	32 mm
Capaciteit in staal	13 mm
Capaciteit in beton	28 mm
Opgenomen vermogen	850 W
Slagenergie	2,9 J
Toerental onbelast	0 - 1.100 tr/min.
Aantal slagen belast	0 - 4.300 /min.
Vibratieniveau	11,5 (Tri-axial) m/sec <sup>2</sup> .
L x B x H	400 x 80 x 198 mm
Gewicht	3,2 kg

### DH28PCYWSZ

SDS-PLUS Boor-hakhamer

EAN 4966376284214



**Standaard toebehoren**

1 handgreep - 1 diepteanslag - 1 kunststof koffer



**Technische specificaties**

Capaciteit in hout	32 mm
Capaciteit in staal	13 mm
Capaciteit in beton	28 mm
Kroonboren	50 mm
Opgenomen vermogen	850 W
Slagenergie	3 J
Toerental onbelast	0 - 1.100 tr/min.
Aantal slagen belast	0 - 4.300 /min.
L x B x H	367 x 80 x 198 mm
Gewicht	2,8 kg

## DH26PCW1Z

SDS-PLUS Boor-hakhamer

EAN 4966376283552



<b>Standaard toebehoren</b>	
1 handgreep - 1 diepteanslag - 1 HSC I	
<b>Technische specificaties</b>	
Capaciteit in hout	32 mm
Capaciteit in steen	26 mm
Capaciteit in beton	26 mm
Kroonboren	50 mm
Opgenomen vermogen	830 W
Slagenergie	2,7 J
Toerental onbelast	0 - 1.100 tr/min.
Aantal slagen belast	0 - 4.300 /min.
L x B x H	367 x 80 x 198 mm
Gewicht	2,8 kg

## DH26PCWSZ

SDS-PLUS Boor-hakhamer

EAN 4966376283569



<b>Standaard toebehoren</b>	
1 handgreep - 1 diepteanslag - 1 kunststof koffer	
<b>Technische specificaties</b>	
Capaciteit in hout	32 mm
Capaciteit in staal	13 mm
Capaciteit in beton	26 mm
Kroonboren	50 mm
Opgenomen vermogen	830 W
Slagenergie	2,7 J
Toerental onbelast	0 - 1.100 tr/min.
Aantal slagen belast	0 - 4.300 /min.
L x B x H	367 x 80 x 198 mm
Gewicht	2,8 kg

## DH24PHWSZ

SDS-PLUS Boor-hakhamer

EAN 4966376283088



<b>Standaard toebehoren</b>	
1 handgreep - 1 diepteanslag - 1 kunststof koffer	
<b>Technische specificaties</b>	
Capaciteit in hout	32 mm
Capaciteit in staal	13 mm
Capaciteit in beton	24 mm
Kroonboren	25 - 50 mm
Opgenomen vermogen	730 W
Slagenergie	2,7 J
Toerental onbelast	0 - 1.050 tr/min.
Aantal slagen belast	0 - 3.950 /min.
L x B x H	367 x 80 x 198 mm
Gewicht	2,7 kg

**DH52MEYWSZ**  
SDS-MAX Boor-hakhamer  
EAN 4966376285327



**DH52ME**



**Standaard toebehoren**  
1 handgreep - 1 diepteanslag - 1 tube vet  
1 kunststof koffer

**Technische specificaties**

Capaciteit in beton	52 mm
Kroonboren	160 mm
Opgenomen vermogen	1.500 W
Slagenergie	22 J
Toerental belast	100 - 260 tr/min.
Aantal slagen belast	1.000 - 2.400 /min.
Vibratieniveau	9,8 (Tri-axial) m/sec <sup>2</sup> .
L x B x H	585 x 116 x 263 mm
Gewicht	11,5 kg

**DH45MEYWSZ**  
SDS-MAX Boor-hakhamer  
EAN 4966376285020



**Standaard toebehoren**  
1 handgreep - 1 diepteanslag - 1 tube vet  
1 kunststof koffer

**Technische specificaties**

Capaciteit in beton	45 mm
Kroonboren	125 mm
Opgenomen vermogen	1.500 W
Slagenergie	13,4 J
Toerental belast	120 - 310 tr/min.
Aantal slagen belast	1.200 - 2.950 /min.
Vibratieniveau	8,8 (Tri-axial) m/sec <sup>2</sup> .
L x B x H	535 x 116 x 255 mm
Gewicht	9,5 kg

**DH40MEYWSZ**  
SDS-MAX Boor-hakhamer  
EAN 4966376284733



**Standaard toebehoren**  
1 handgreep - 1 diepteanslag - 1 tube vet  
1 kunststof koffer

**Technische specificaties**

Capaciteit in beton	40 mm
Kroonboren	105 mm
Opgenomen vermogen	1.150 W
Toerental belast	250 - 500 tr/min.
Aantal slagen belast	1.430 - 2.850 /min.
Slagenergie	11 Joule
Vibratie niveau belast	8,0 m/sec <sup>2</sup> .
L x B x H	477 x 108 x 242 mm
Gewicht	7,5 kg

## DH40MCWSZ

SDS-MAX Boor-hakhamer





EAN 4966376284658



### Standaard toebehoren

1 handgreep - 1 diepteanslag - 1 tube vet  
1 kunststof koffer

### Technische specificaties

	Capaciteit in beton	40 mm
	Kroonboren	105 mm
	Opgenomen vermogen	1.100 W
	Slagenergie	8,5 J
	Toerental belast laag	510 tr/min
	Aantal slagen belast	2.800 /min.
	Vibratieniveau	16,5 (Tri-axial) m/sec <sup>2</sup> .
	Vibratie onzekerheidsfactor	1,5 (K) m/sec <sup>2</sup> .
	Geluidsniveau	86 dB
	L x B x H	448 x 105 x 255 mm
	Gewicht	7,1 kg

## H90SGWAZ





Hakhamer 28mm zeskant

EAN 4966376289127



### Standaard toebehoren

1 sleutel 6 mm

	<b>Technische specificaties</b>	
	Opgenomen vermogen	2.000 W
	Slagenergie	70 J
	Aantal slagen belast	1.000 /min
	Vibratieniveau	7,7 (Tri-axial) m/sec <sup>2</sup> .
	Geluidsniveau	108 dB
	L x H	860 x 625 mm
	Gewicht	32 kg

## H70SDLAZ



Hakhamer 28mm zeskant

EAN 4966376288977



### Standaard toebehoren

2 sleutels

	<b>Technische specificaties</b>	
	Opgenomen vermogen	1.240 W
	Slagenergie	42 J
	Aantal slagen belast	1.400 /min.
	Vibratieniveau	14,0 (Tri-axial) m/sec <sup>2</sup> .
	Geluidsniveau	85 dB
	L x H	722 x 554 mm
	Gewicht	20 kg

### H70SALAZ

Hakhamer 30mm zeskant

EAN 4966376288960



**Standaard toebehoren**  
1 puntbeitel - 2 sleutels



**Technische specificaties**

Opgenomen vermogen	1.240 W
Slagenergie	42 J
Aantal slagen belast	1.400 /min.
Vibratieniveau	14,0 (Tri-axial) m/sec <sup>2</sup> .
Geluidsniveau	85 dB
L x B	628 x 554 mm
Gewicht	18 kg

### H65SD3WTZ

Hakhamer 28mm zeskant

EAN 4966376288953



**Standaard toebehoren**  
1 handgreep - 1 kunststof koffer



**Technische specificaties**

Opgenomen vermogen	1.340 W
Slagenergie	45 J
Slagenergie EPTA	28 J
Aantal slagen belast	1.400 /min.
Vibratieniveau	13,9 (Tri-axial) m/sec <sup>2</sup> .
Geluidsniveau	104 dB
L x H	848 x 251 mm
Gewicht	20,1 kg

### H65SB3WTZ

Hakhamer 30mm zeskant

EAN 4966376288854



**Standaard toebehoren**  
1 puntbeitel 410 mm - 1 kunststof koffer



**Technische specificaties**

Opgenomen vermogen	1.340 W
Slagenergie	45 J
Slagenergie EPTA	28 J
Aantal slagen belast	1.400 /min.
Vibratieniveau	15,5 (Tri-axial) m/sec <sup>2</sup> .
Geluidsniveau	103 dB
L x H	731 x 251 mm
Gewicht	18 kg

## H60MEYWTZ

SDS-MAX hakhamer

EAN 4966376288717



### Standaard toebehoren

1 handgreep - 1 puntbeitel - 1 kunststof koffer



### Technische specificaties

Opgenomen vermogen	1.500 W
Slagenergie	26,5 J
Aantal slagen belast	1.500 - 2.100 /min.
Vibratieniveau	11 (Tri-axial) m/sec <sup>2</sup> .
Geluidsdruk niveau	78 dB Lpa
L x B x H	585 x 116 x 263 mm
Gewicht	12,2 kg



## H60MCWSZ

SDS-MAX hakhamer

EAN 4966376288472



### Standaard toebehoren

1 handgreep - 1 puntbeitel - 1 kunststof koffer



### Technische specificaties

Opgenomen vermogen	1.250 W
Slagenergie	22 J
Aantal slagen belast	1.600 /min.
Geluidsniveau	85 dB
L x B x H	570 x 121 x 280 mm
Gewicht	10,2 kg



## H45MEYWTZ

SDS-MAX hakhamer

EAN 4966376288212



### Standaard toebehoren

1 handgreep - 1 puntbeitel - 1 kunststof koffer



### Technische specificaties

Opgenomen vermogen	1.150 W
Slagenergie	13,6 J
Slagenergie EPTA	8,5 J
Aantal slagen belast	1.430 - 2.850 /min.
Vibratieniveau	8 (Tri-axial) m/sec <sup>2</sup> .
L x B x H	480 x 108 x 237 mm
Gewicht	7,3 kg



**H25PVWSZ**

SDS-PLUS hakhamer

EAN 4966376287680



**Standaard toebehoren**

1 kunststof koffer



**Technische specificaties**



Opgenomen vermogen

500 W



Slagenergie

2,2 J



Aantal slagen belast

3.200 /min.



Geluidsniveau

80 dB



L x B x H

320 x 102 x 195 mm



Gewicht

3,2 kg

# Slijpmachines



## G13BYWQZ

Haakse slijpmachine met rem

EAN 4966376273515



**Standaard toebehoren**

1 zijhandgreep



**Technische specificaties**

Diameter slijpschijf	125 mm
Opgenomen vermogen	1.700 W
Toerental belast	11.000 tr/min.
Greepdiameter	208 mm
Vibratieniveau	4,0 (Tri-axial) m/sec <sup>2</sup> .
Geluidsniveau	93 dB
L x H	335 x 78 mm
Gewicht	2,8 kg



## G13YGWQZ

Haakse slijpmachine

EAN 4966376275113



**Standaard toebehoren**

1 zijhandgreep



**Technische specificaties**

Diameter slijpschijf	125 mm
Opgenomen vermogen	1.700 W
Toerental onbelast	11.000 tr/min.
Greepdiameter	208 mm
Vibratieniveau	4,0 (Tri-axial) m/sec <sup>2</sup> .
Geluidsniveau	93 dB
L x H	315 x 78 mm
Gewicht	2,7 kg



## G13VEWQZ

Haakse slijpmachine

EAN 4966376275021



**Standaard toebehoren**

1 sleutel - 1 zijhandgreep - 1 speciale onderlegmoer  
1 afbraamschijf



**Technische specificaties**

Diameter slijpschijf	125 mm
Spindel	M14
Opgenomen vermogen	1.320 W
Toerental onbelast	2.800 - 10.000 tr/min.
Greepdiameter	176 mm
Vibratieniveau	5,8 (Tri-axial) m/sec <sup>2</sup> .
Geluidsniveau	84 dB
L x H	305 x 62 mm
Gewicht	2,1 kg

## G13VAWKZ

Haakse slijpmachine

EAN 4966376274970



**Standaard toebehoren**

1 sleutel - 1 zijhandgreep



**Technische specificaties**

Diameter slijpschijf	125 mm
Spindel	M14
Opgenomen vermogen	1.500 W
Toerental onbelast	2.800 - 10.000 / 10.000 tr/min.
Geluidsniveau	86 dB
L x H	297,5 x 70 mm
Gewicht	2 kg

## G13YC2LAZ

Haakse slijpmachine

EAN 4966376275076



<b>Standaard toebehoren</b>	
1 sleutel - 1 inbusleutel - 1 zijhandgreep	
<b>Technische specificaties</b>	
Diameter slijpschijf	125 mm
Spindel	M14
Opgenomen vermogen	1.500 W
Toerental onbelast	10.500 tr/min.
Greepdiameter	220 mm
Geluidsniveau	84 dB
L x H	323 x 70 mm
Gewicht	2 kg

## G13SB3YZZ

Haakse slijpmachine

EAN 4966376273805



<b>Standaard toebehoren</b>	
1 sleutel - 1 zijhandgreep - 1 kunststof koffer	
<b>Technische specificaties</b>	
Diameter slijpschijf	125 mm
Spindel	M14
Opgenomen vermogen	1.300 W
Toerental onbelast hoog	11.000 tr/min.
Geluidsniveau	86 dB
L x H	283 x 70 mm
Gewicht	1,9 kg

## G13BAWQZ

Haakse slijpmachine met rem

EAN 4966376273508

**LVP**  
USER VIBRATION PROTECTION



<b>Standaard toebehoren</b>	
1 zijhandgreep - 1 speciale onderlegmoer	
<b>Technische specificaties</b>	
Diameter slijpschijf	125 mm
Opgenomen vermogen	1.250 W
Toerental onbelast	11.000 tr/min.
Greepdiameter	208 mm
Vibratieniveau	4,0 (Tri-axial) m/sec <sup>2</sup> .
Geluidsniveau	93 dB
L x H	335 x 78 mm
Gewicht	2,7 kg

## G13SE2YZZ

Haakse slijpmachine

EAN 4966376274000



<b>Standaard toebehoren</b>	
1 sleutel - 1 zijhandgreep - 1 afbraamschijf 1 kunststof koffer	
<b>Technische specificaties</b>	
Diameter slijpschijf	125 mm
Spindel	M14
Opgenomen vermogen	1.200 W
Toerental onbelast	11.000 tr/min.
Geluidsniveau	84 dB
L x H	321 x 70 mm
Gewicht	1,9 kg

## G13SE2YHZ

Haakse slijpmachine

EAN 4966376273997



### Standaard toebehoren

1 sleutel - 1 zijhandgreep - 1 afbraamschijf



### Technische specificaties

Diameter slijpschijf	125 mm
Spindel	M14
Opgenomen vermogen	1.200 W
Toerental onbelast	11.000 tr/min.
Geluidsniveau	84 dB
L x H	321 x 70 mm
Gewicht	1,9 kg



## G13SWYMZ

Haakse slijpmachine met diamantzaagblad

EAN 4966376274925



### Standaard toebehoren

1 sleutel - 1 zijhandgreep - 1 diamantzaagblad

### Technische specificaties

Diameter slijpschijf	125 mm
Spindel	M14
Opgenomen vermogen	1.200 W
Toerental onbelast	12.000 tr/min.
Greepdiameter	202 mm
Geluidsniveau	90 dB
L x H	277 x 66 mm
Gewicht	1,8 kg



## G13SR4YGZ

Haakse slijpmachine

EAN 4966376274543



### Standaard toebehoren

1 sleutel - 1 zijhandgreep - 1 diamantzaagblad

### Technische specificaties

Diameter slijpschijf	125 mm
Spindel	M14
Opgenomen vermogen	730 W
Toerental onbelast	10.000 tr/min.
Vibratieniveau	7,7 (Tri-axial) m/sec <sup>2</sup> .
Geluidsniveau	86 dB
L x H	258 x 63 mm
Gewicht	1,8 kg



## G18UDYWKZ

Haakse slijpmachine

EAN 4966376276004

**UVP**  
ULTRA VIBRATION PROTECTION



### Standaard toebehoren

1 sleutel - 1 zijhandgreep

### Technische specificaties

Diameter slijpschijf	180 mm
Spindel	M14
Opgenomen vermogen	2.600 W
Toerental onbelast	8.500 tr/min.
Vibratieniveau onbelast	4,8 (Tri-Axial) m/sec <sup>2</sup> .
Vibratieniveau belast	3,3 (Tri-Axial) m/sec <sup>2</sup> .
zij	4,8 (Tri-Axial) m/sec <sup>2</sup> .
Geluidsniveau	89 dB
L x H	500 x 83 mm
Gewicht	6,4 kg



## G18SW2WAZ

Haakse slijpmachine



EAN 4966376275946



### Standaard toebehoren

1 sleutel - 1 zijhandgreep

### Technische specificaties

	Diameter slijpschijf	180 mm
	Spindel	M14
	Opgenomen vermogen	2.200 W
	Toerental onbelast	8.500 tr/min.
	Geluidsniveau	89 dB
	L x H	469 x 82 mm
	Gewicht	4,9 kg

## G23SW2CPZ

G23SW2 en G13SR4 Haakse slijpmachineset in kunststof koffer



EAN 8717574061727



### Standaard toebehoren

2 sleutels - 2 zijhandgrepen - 1 diamantzaagblad 230 mm  
1 diamantzaagblad 125 mm - 1 kunststof koffer

### Technische specificaties

	Diameter slijpschijf	230 / 125 mm
	Spindel	M14
	Opgenomen vermogen	2.200 / 730 W
	Toerental onbelast	6.600 / 10.000 tr/min.
	Geluidsniveau	92 / 86 dB
	L x H	469 x 82 / 258 x 63 mm
	Gewicht	5,1 / 1,8 kg

## G23STCPZ

G23ST en G13STA Haakse slijpmachineset in kartonnen doos

EAN 8717574061734



### Standaard toebehoren

2 sleutels - 2 zijhandgrepen - 1 diamantzaagblad 230 mm  
1 diamantzaagblad 125 mm

### Technische specificaties

	Diameter slijpschijf	230 / 125 mm
	Spindel	M14
	Opgenomen vermogen	2.000 / 600 W
	Toerental onbelast	6.600 / 11.500 tr/min.
	Geluidsniveau	89 / 88 dB
	L x H	469 x 82 / 254 x 63 mm
	Gewicht	5,1 / 1,8 kg

## G23UDYLAZ

Haakse slijpmachine

EAN 4966376277223



### Standaard toebehoren

1 sleutel - 1 zijhandgreep



### Technische specificaties

Diameter slijpschijf	230 mm
Spindel	M14
Opgenomen vermogen	2.600 W
Toerental onbelast	6.600 tr/min.
Vibratieniveau	4,8 (Tri-axial) m/sec <sup>2</sup> .
Geluidsniveau	89 dB
L x H	500 x 83 mm
Gewicht	6,4 kg



## G23MRUAW6Z

Haakse slijpmachine in koffer en speciale onderlegmoer

EAN 4966376276172



### Standaard toebehoren

1 sleutel - 1 zijhandgreep - 1 onderlegmoer  
1 kunststof koffer



### Technische specificaties

Diameter slijpschijf	230 mm
Spindel	M14
Opgenomen vermogen	2.500 W
Toerental onbelast laag	6.600 tr/min.
Geluidsniveau	88 dB
L x H	492 x 83 mm
Gewicht	5,5 kg



## G23MRUAWKZ

Haakse slijpmachine

EAN 4966376276189



### Standaard toebehoren

1 sleutel - 1 zijhandgreep



### Technische specificaties

Diameter slijpschijf	230 mm
Spindel	M14
Opgenomen vermogen	2.500 W
Toerental onbelast	6.600 tr/min.
Geluidsniveau	88 dB
L x H	492 x 83 mm
Gewicht	5,5 kg



## G23UCWKZ

Haakse slijpmachine

EAN 4966376277193



### Standaard toebehoren

1 sleutel - 1 zijhandgreep



### Technische specificaties

Diameter slijpschijf	230 mm
Spindel	M14
Opgenomen vermogen	2.500 W
Toerental onbelast	6.600 tr/min.
Geluidsniveau	88 dB
L x H	478 x 83 mm
Gewicht	6,4 kg



## G23SC3UXZ



Haakse slijpmachine

EAN 4966376276318



**Standaard toebehoren**  
1 sleutel 1 zijhandgreep

**Technische specificaties**

	Diameter slijpschijf	230 mm
	Spindel	M14
	Opgenomen vermogen	2.300 W
	Toerental onbelast	6.600 tr/min.
	Geluidsniveau	88 dB
	L x H	478 x 83 mm
	Gewicht	5 kg

## G23SWUWGZ



Haakse slijpmachine

EAN 4966376277124



**Standaard toebehoren**  
1 sleutel - 1 zijhandgreep

**Technische specificaties**

	Diameter slijpschijf	230 mm
	Spindel	M14
	Opgenomen vermogen	2.200 W
	Toerental onbelast	6.600 tr/min.
	Geluidsniveau	92 dB
	L x H	468 x 83 mm
	Gewicht	5,6 kg

## G23SW2WWZ

Haakse slijpmachine met diamantzaagblad in koffer



EAN 4966376277056



**Standaard toebehoren**

1 sleutel - 1 zijhandgreep - 1 diamantzaagblad  
1 kunststof koffer

**Technische specificaties**

	Diameter slijpschijf	230 mm
	Spindel	M14
	Opgenomen vermogen	2.200 W
	Toerental onbelast laag	6.600 tr/min.
	Geluidsniveau	89 dB
	L x H	469 x 82 mm
	Gewicht	5,1 kg

## G23SW2W7Z

Haakse slijpmachine



EAN 4966376277025



**Standaard toebehoren**

1 sleutel - 1 zijhandgreep - 1 diamantzaagblad

**Technische specificaties**

	Diameter slijpschijf	230 mm
	Spindel	M14
	Opgenomen vermogen	2.200 W
	Toerental onbelast	6.600 tr/min.
	Geluidsniveau	89 dB
	L x H	469 x 82 mm
	Gewicht	5,1 kg



## G23STWAZ

Haakse slijpmachine

EAN 4966376276752



### Standaard toebehoren

1 diamantzaagblad - 1 sleutel - 1 zijhandgreep

### Technische specificaties

Diameter schijf	230 mm
Opgenomen vermogen	2.000 W
Toerental onbelast	6.600 tr/min.
Spindel	M14
Geluidsniveau	89 dB
L x H	468 x 82 mm
Gewicht	5,1 kg



## G13SB3SDZ

Diamant slijpmachine arbo met stofkap

EAN 8717574061741



### Standaard toebehoren

1 zijhandgreep - 1 sleutel - 1 HSCII

### Technische specificaties

Diameter slijpschijf	125 mm
Spindel	M14
Opgenomen vermogen	1.300 W
Geluidsniveau	86 dB
L x H	283 x 70 mm
Gewicht	1,9 kg



## CM5SBU1Z

Diamant slijpmachine met stofkap

EAN 4966376282043



### Standaard toebehoren

1 zijhandgreep - 1 sleutel - 1 rubber manchet  
1 kunststof koffer

### Technische specificaties

Diameter slijpschijf	125 mm
Opgenomen vermogen	1.300 W
Toerental onbelast	11.000 tr/min.
Geluidsniveau	86 dB
Lengte	314 mm
Gewicht	2,9 kg



## CM9UBYWSZ

Diamant slijpmachine met stofkap

EAN 4966376282135

**UVP**  
ULTRA VIBRATION PROTECTION



### Standaard toebehoren

1 sleutel - 1 rubber manchet - 1 pipehandgreep  
1 kunststof koffer

### Technische specificaties

Diameter slijpschijf	230 mm
Opgenomen vermogen	2.600 W
Toerental onbelast	6.600 tr/min.
Geluidsniveau	89 dB
Lengte	652 mm
Gewicht	8,1 kg



# Slijpmachines Diamant slijpmachines / Haakse doorslijpmachine / Rechte slijpmachines

## CM9SRWSZ

Diamant slijpmachine met stofkap

EAN 4966376282098



### Standaard toebehoren

1 sleutel - 1 rubber manchet - 1 pipehandgreep  
1 kunststof koffer

### Technische specificaties

Diameter slijpschijf	180 mm
Slijpdiepte	60 mm
Opgenomen vermogen	2.000 W
Toerental onbelast	6.600 tr/min.
Geluidsniveau	86 dB
Lengte	615 mm
Gewicht	7,7 kg



## CM12YUAZ

Haakse doorslijpmachine

EAN 4966376281725



### Standaard toebehoren

1 sleutel - 1 adapterslang (rubber) - 1 veiligheidsbril  
1 pipehandgreep

### Technische specificaties

Diameter slijpschijf	305 mm
Asgat	22,2 mm
Opgenomen vermogen	2.400 W
Toerental onbelast	5.000 tr/min.
Geluidsniveau	92,5 dB
L x H	633 x 367 mm
Gewicht	11 kg



## GP5VWAZ

Rechte slijpmachine

EAN 4966376277759



### Standaard toebehoren

1 zijhandgreep - 1 spantang 6 mm - 2 steeksleutels

### Technische specificaties

Slijpstiften	0 - 50 mm
Opgenomen vermogen	760 W
Toerental onbelast	2.000 - 8.300 tr/min.
Spantang	6 mm
Greepdiameter	200 mm
Lengte	406 mm
Gewicht	1,9 kg



## GP3VWAZ

Rechte slijpmachine

EAN 4966376277704



### Standaard toebehoren

1 zijhandgreep - 1 spantang 6 mm - 2 sleutels

### Technische specificaties

Slijpstiften	0 - 25 mm
Opgenomen vermogen	760 W
Toerental onbelast	7.000 - 29.000 tr/min.
Spantang	6 mm
Greepdiameter	200 mm
Lengte	406 mm
Gewicht	1,8 kg



### GP2S2UTZ

Rechte slijpmachine

EAN 4966376277629



**Standaard toebehoren**  
2 sleutels - 1 spantang 6 mm

**Technische specificaties**

Slijpstiften	0 - 25 mm
Opgenomen vermogen	520 W
Toerental onbelast	29.000 tr/min.
Spantang	6 mm
Greepdiameter	200 mm
Lengte	359 mm
Gewicht	1,7 kg



### SAT180L2Z

Haakse schuur- en polijstmachine

EAN 4966376278879



**Standaard toebehoren**

2 sleutels - 1 handgreep - 1 steunschijf - 5 verschillende schuur-schijven - 1 lamswollen vacht

**Technische specificaties**

Diameter steunschijf	178 mm
Opgenomen vermogen	750 W
Toerental onbelast	1.900 - 3.400 tr/min.
Spindel	M14
Lengte	395 mm
Gewicht	2,9 kg



### SP18VAUAZ

Haakse schuur- en polijstmachine

EAN 4966376279241



**Standaard toebehoren**

1 sleutel - 1 handgreep - 1 steunschijf - 1 fiberschijf  
1 lamswollen vacht

**Technische specificaties**

Diameter steunschijf	180 mm
Spindel	M14
Opgenomen vermogen	1.250 W
Toerental onbelast	0 - 3.400 tr/min.
L x H	415 x 126 mm
Gewicht	2,8 kg

### SAY150AM1Z

Excentrische haakse schuurmachine met plak steunschijf

EAN 4966376279005



**Standaard toebehoren**

1 sleutel - 1 handgreep - 1 steunschijf

**Technische specificaties**

Diameter steunschijf	150 mm
Opgenomen vermogen	380 W
Toerental onbelast	7.000 tr/min.
Gereedschapopname	5/16"
Lengte	279 mm
Gewicht	2,1 kg



**SAY150AV2Z**

Excentrische haakse schuurmachine met velcro steunschijf

EAN 8717574061765



**Standaard toebehoren**

1 sleutel - 1 handgreep - 1 steunschijf

**Technische specificaties**

Diameter steunschijf	150 mm
Opgenomen vermogen	380 W
Toerental onbelast	7.000 tr/min.
Gereedschapopname	5/16"
Lengte	279 mm
Gewicht	2,1 kg



**CN16SAUAZ**

Knabbelschaar

EAN 4966376269969



**Standaard toebehoren**

2 sleutels - 1 stempel - 1 matrijs

**Technische specificaties**

Capaciteit in staal	1,6 mm
Capaciteit in RVS	1,2 mm
Capaciteit aluminium	2,3 mm
Opgenomen vermogen	400 W
Toerental onbelast	2.300 tr/min.
Kleine radius	40mm
Spoorbreedte	5 mm
Geluidsniveau	77 dB
L x B x H	250 x 184 x 176 mm
Gewicht	1,6 kg



**CE16SAUAZ**

Platenschaar

EAN 4966376269778



**Standaard toebehoren**

1 sleutel - 1 set messen - 1 voelermaat

**Technische specificaties**

Capaciteit in staal	1,6 mm
Capaciteit in RVS	1,2 mm
Capaciteit aluminium	2,3 mm
Opgenomen vermogen	400 W
Toerental onbelast	4.700 tr/min.
Kleine radius	25 mm
Geluidsniveau	79 dB
L x B x H	258 x 184 x 146 mm
Gewicht	1,7 kg



# Zaagmachines



## C9BU3WBZ

Cirkelzaagmachine





EAN 4966376293322



### Standaard toebehoren

1 zaagblad - 1 langsgelieder - 1 inbussleutel - 1 zijgreep  
1 stofafzuigadapter - 1 kunststof koffer

### Technische specificaties

	Diameter zaagblad	235 mm
	Zaagdiepte	86 mm
	In verstek 45°	65 mm
	Asgat	30 mm
	Opgenomen vermogen	2.000 W
	Toerental onbelast	5.200 tr/min.
	Geluidsniveau	88 dB
	L x B x H	397 x 282 x 298 mm
	Gewicht	7,2 kg

## C9U3WBZ

Cirkelzaagmachine





EAN 4966376293520



### Standaard toebehoren

1 zaagblad - 1 langsgelieder - 1 inbussleutel - 1 zijgreep  
1 stofafzuigadapter - 1 kunststof koffer

### Technische specificaties

	Diameter zaagblad	235 mm
	Zaagdiepte	86 mm
	In verstek 45°	65 mm
	Asgat	30 mm
	Opgenomen vermogen	2.000 W
	Toerental onbelast	5.200 tr/min.
	Geluidsniveau	88 dB
	L x B x H	397 x 282 x 298 mm
	Gewicht	7,2 kg

## C7UYLXZ

Cirkelzaagmachine





EAN 4966376292967



### Standaard toebehoren

1 zaagblad - 1 langsgelieder - 1 geleider adapter  
1 inbussleutel - 1 stofafzuigadapter - 1 HSC IV

### Technische specificaties

	Diameter zaagblad	190 mm
	Zaagdiepte	78 mm
	In verstek 45°	55 mm
	Asgat	20 mm
	Opgenomen vermogen	1.300 W
	Toerental onbelast	5.500 tr/min.
	Geluidsniveau	86 dB
	L x B x H	331 x 236 x 253 mm
	Gewicht	4,2 kg

## C7BUMW1Z

Cirkelzaagmachine

EAN 4966376291823



### Standaard toebehoren

1 zaagblad - 1 langsgeleider - 1 HSC IV

### Technische specificaties

Diameter zaagblad	190 mm
Zaagdiepte	66 mm
In verstek 45°	48 mm
Asgat	30 mm
Opgenomen vermogen	1.300 W
Toerental onbelast	5.800 tr/min.
Geluidsniveau	83 dB
L x B x H	366 x 241 x 250 mm
Gewicht	5,2 kg



## C7U3W1Z

Cirkelzaagmachine

EAN 4966376292707



### Standaard toebehoren

1 zaagblad - 1 langsgeleider - 1 stofafzuigadapter - 1 HSC IV

### Technische specificaties

Diameter zaagblad	190 mm
Zaagdiepte	66 mm
In verstek 45°	48 mm
Asgat	30 mm
Opgenomen vermogen	1.300 W
Toerental onbelast	5.800 tr/min.
Geluidsniveau	83 dB
L x B x H	314 x 227 x 250 mm
Gewicht	4,7 kg



## C7MFALAZ

Cirkelzaagmachine

EAN 4966376292035



### Standaard toebehoren

1 sleutel - 1 zaagblad - 1 langsgeleider - 1 inbussleutel

### Technische specificaties

Diameter zaagblad	190 mm
Zaagdiepte	68 mm
In verstek 45°	46 mm
Asgat	30 mm
Opgenomen vermogen	1.010 W
Toerental onbelast	5.800 tr/min.
Geluidsniveau	86 dB
L x B x H	291 x 210 x 242 mm
Gewicht	3,6 kg



## C7SSUTZ

Cirkelzaagmachine

EAN 4966376292448



### Standaard toebehoren

1 langsgelieder - 1 inbusleutel 5 mm

### Technische specificaties

Diameter zaagblad	190 mm
Zaagdiepte	68 mm
In verstek 45°	46 mm
Asgat	30 mm
Opgenomen vermogen	1.050 W
Toerental onbelast	5.500 tr/min.
Geluidsniveau	85 dB
L x B x H	291 x 210 x 242 mm
Gewicht	3,4 kg



## C6U3W1Z

Cirkelzaagmachine

EAN 4966376291564



### Standaard toebehoren

1 langsgelieder - 1 inbusleutel - 1 HSC IV

### Technische specificaties

Diameter zaagblad	165 mm
Zaagdiepte	54 mm
In verstek 45°	40 mm
Opgenomen vermogen	1.300 W
Toerental onbelast	5.800 tr/min.
Geluidsniveau	84 dB
L x B x H	290 x 221 x 240 mm
Gewicht	4,2 kg



## CJ160VW1Z

Decoupeerzaagmachine

EAN 4966376293902



### Standaard toebehoren

1 HSC II

### Technische specificaties

Capaciteit in hout	160 mm
Capaciteit in staal	10 mm
Kleine radius	26 mm
Opgenomen vermogen	800 W
Toerental onbelast	800 - 2.800 tr/min.
Vibratieniveau	5,4 (Tri-axial) m/sec <sup>2</sup> .
Slaglengte	26 mm
Geluidsniveau	84 dB
L x B x H	249 x 75 x 205 mm
Gewicht	2,5 kg





**CJ160VAW1Z**  
Decoupeerzaagmachine  
EAN 4966376293940



	<b>Standaard toebehoren</b> 1 HSC II	
	<b>Technische specificaties</b>	
	Capaciteit in hout	160 mm
	Capaciteit in staal	10 mm
	Kleine radius	26 mm
	Opgenomen vermogen	800 W
	Toerental onbelast	800 - 2.800 tr/min.
	Vibratieniveau	5,9 (Tri-axial) m/sec <sup>2</sup> .
	Slaglengte	26 mm
	Geluidsniveau	85 dB
	L x B x H	273 x 75 x 190 mm
	Gewicht	2,5 kg

**CJ90VSTWAZ**  
Decoupeerzaagmachine  
EAN 4966376294237



	<b>Standaard toebehoren</b> 1 zaagblad - 1 sleutel - 1 kunststof koffer	
	<b>Technische specificaties</b>	
	Capaciteit in hout	90 mm
	Capaciteit in staal	8 mm
	Kleine radius	25 mm
	In verstek	45°
	Opgenomen vermogen	705 W
	Toerental onbelast	850 - 3.000 tr/min.
	Slaglengte	20 mm
	Geluidsniveau	85 dB
	L x B x H	228 x 66 x 202 mm
	Gewicht	2,2 kg

**CJ90VASTWAZ**  
Decoupeerzaagmachine  
EAN 4966376294022



	<b>Standaard toebehoren</b> 1 zaagblad - 1 sleutel - 1 kunststof koffer	
	<b>Technische specificaties</b>	
	Capaciteit in hout	90 mm
	Capaciteit in staal	8 mm
	Kleine radius	25 mm
	In verstek	45°
	Opgenomen vermogen	705 W
	Toerental onbelast	850 - 3.000 tr/min.
	Slaglengte	20 mm
	Geluidsniveau	86 dB
	L x B x H	246 x 66 x 187 mm
	Gewicht	2,5 kg

## CR13VBYWSZ

Reciprozaagmachine

EAN 4966376282494

**LVP**  
LIVE VIBRATION PROTECTION



**Standaard toebehoren**  
1 zaagblad - 1 kunststof koffer

**Technische specificaties**

Capaciteit in hout	300 mm
Capaciteit in staal	19 mm
Max. diam. ronde stalen buis	130 mm
Opgenomen vermogen	1.150 W
Toerental onbelast	0 - 3.000 tr/min.
Vibratieniveau	6,8 (Tri-axial) m/sec <sup>2</sup> .
Slaglengte	32 mm
Geluidsniveau	93 dB
L x B x H	465 x 103 x 167 mm
Gewicht	4,4 kg



## CR13V2WSZ

Reciprozaagmachine

EAN 4966376282357



**Standaard toebehoren**  
1 sleutel - 1 zaagblad - 1 kunststof koffer

**Technische specificaties**

Capaciteit in hout	300 mm
Capaciteit in staal	19 mm
Max. diam. ronde stalen buis	130 mm
Opgenomen vermogen	1.010 W
Toerental onbelast	0 - 2.800 tr/min.
Slaglengte	29 mm
Geluidsniveau	88 dB
L x B x H	435 x 95 x 165 mm
Gewicht	3,3 kg



## CV350VW1Z

Multi tool

EAN 4966376294671

**ACS**  
ACTIVE CONTROL SYSTEM



**Standaard toebehoren**  
1 set toebehoren - 1 HSC II

**Technische specificaties**

Standaard mode	6.000 - 20.000 min.
Auto mode	15.000 min.
Oscillatie hoek	3,2"
Opgenomen vermogen	350 W
L x H	280 x 96 mm
Gewicht	1,5 kg



## C8FSHEUAZ

Afkortzaagmachine

EAN 4966376293285



### Standaard toebehoren

1 sleutel - 1 stofzak - 1 materiaal klem - 1 zaagblad

### Technische specificaties

Diameter zaagblad	216 mm
Zaagcapaciteit	65 x 312 mm
In verstek 45°	65 x 220 mm
Kantel links 45°	45 x 312 mm
Dubbel verstek links 45°	45 x 220 mm
Afkorten rechts	0 - 57°
Afkorten links	0 - 45°
Kantel rechts	0 - 5°
Kantel links	0 - 48°
Opgenomen vermogen	1.050 W
Toerental onbelast	5.500 tr/min.
L x B x H	790 x 555 x 485 mm
Gewicht	15 kg



## C8FSHEUAWZ

Afkortzaagmachine met standaard 712650

EAN 8717574061796



### Standaard toebehoren

1 zaagstandaard 712650 - 1 sleutel - 1 stofzak  
1 materiaal klem - 1 zaagblad

### Technische specificaties

Diameter zaagblad	216 mm
Zaagcapaciteit	65 x 312 mm
In verstek 45°	65 x 220 mm
Kantel links 45°	45 x 312 mm
Dubbel verstek links 45°	45 x 220 mm
Afkorten rechts	0 - 57°
Afkorten links	0 - 45°
Kantel rechts	0 - 5°
Kantel links	0 - 48°
Opgenomen vermogen	1.050 W
Toerental onbelast	5.500 tr/min.
L x B x H	790 x 555 x 485 mm
Gewicht	15 kg



## C8FSEUAZ

Afkortzaagmachine

EAN 4966376293186



### Standaard toebehoren

1 sleutel - 1 stofzak - 1 materiaal klem - 1 zaagblad

### Technische specificaties

Diameter zaagblad	216 mm
Zaagcapaciteit	65 x 312 mm
In verstek 45°	65 x 220 mm
Asgat	30 mm
Opgenomen vermogen	1.050 W
Toerental onbelast	5.500 tr/min.
L x B x H	790 x 555 x 485 mm
Gewicht	15 kg



## C8FSEUAWZ

Afkortzaagmachine met standaard 712650

EAN 8717574061789



### Standaard toebehoren

1 zaagstandaard 712650- 1 sleutel - 1 stofzak  
1 materiaal klem - 1 zaagblad



### Technische specificaties

Diameter zaagblad	216 mm
Zaagcapaciteit	65 x 312 mm
In verstek 45°	65 x 220 mm
Asgat	30 mm
Opgenomen vermogen	1.050 W
Toerental onbelast	5.500 tr/min.
L x B x H	790 x 555 x 485 mm
Gewicht	15 kg

## C10FSHUBZ

Afkortzaagmachine

EAN 4966376118007



### Standaard toebehoren

1 sleutel - 1 stofzak - 1 zaagblad



### Technische specificaties

Diameter zaagblad	235 - 255 mm
Zaagcapaciteit	85 x 312 mm
In verstek 45°	85 x 218 mm
Verstek rechts 57°	85 x 165 mm
Kantel links 45°	55 x 305 mm
Kantel rechts 45°	30 x 305 mm
Dubbel verstek links 45°	55 x 218 mm
Dubbel verstek rechts 45°	30 x 218 mm
Opgenomen vermogen	1.090 W
Toerental onbelast	3.800 tr/min.
L x B x H	1.050 x 520 x 615 mm
Gewicht	19,5 kg

## C10FSHWASZ

Afkortzaagmachine met standaard 712650

EAN 8717574048315



### Standaard toebehoren

1 zaagstandaard 712650 -1 sleutel - 1 stofzak - 1 zaagblad



### Technische specificaties

Diameter zaagblad	235 - 255 mm
Zaagcapaciteit	85 x 312 mm
In verstek 45°	85 x 218 mm
Verstek rechts 57°	85 x 165 mm
Kantel links 45°	55 x 305 mm
Kantel rechts 45°	30 x 305 mm
Dubbel verstek links 45°	55 x 218 mm
Dubbel verstek rechts 45°	30 x 218 mm
Opgenomen vermogen	1.090 W
Toerental onbelast	3.800 tr/min.
L x B x H	1.050 x 520 x 615 mm
Gewicht	19,5 kg

## C10FCH2LA

Afkortzaagmachine

EAN 4966376150397



### Standaard toebehoren

2 sleutels - 1 stofzak - 1 lengte aanslag - 1 klem - 1 zaagblad

### Technische specificaties

	Diameter zaagblad	255 mm
	Zaagcapaciteit	89 x 144 mm
	Zaagcapaciteit in hout	59 x 144 / 89 x 101 mm
	In verstek 45°	89 x 102 mm
	Asgat	30 mm
	Opgenomen vermogen	1.520 W
	Toerental onbelast	5.000 tr/min.
	L x B x H	628 x 450 x 561 mm
	Gewicht	11,3 kg

## C10FCH2WAS

Afkortzaagmachine met standaard 712650

EAN 8717574048308



### Standaard toebehoren

1 zaagstandaard 712650 - 2 sleutels - 1 stofzak  
1 lengte aanslag - 1 klem - 1 zaagblad

### Technische specificaties

	Diameter zaagblad	255 mm
	Zaagcapaciteit	89 x 144 mm
	Zaagcapaciteit in hout	59 x 144 / 89 x 101 mm
	In verstek 45°	89 x 102 mm
	Asgat	30 mm
	Opgenomen vermogen	1.520 W
	Toerental onbelast	5.000 tr/min.
	L x B x H	628 x 450 x 561 mm
	Gewicht	11,3 kg

## C12LCHUTZ

Afkortzaagmachine

EAN 4966376290949



### Standaard toebehoren

2 sleutels - 1 stofzak - 1 spantang - 1 zaagblad

### Technische specificaties

	Diameter zaagblad	305 mm
	Zaagcapaciteit	61,5 x 200 / 100 x 100 mm
	Verstek 45°	61,5 x 140 mm
	Kantel links 45°	40 x 200
	Dubbel verstek 45°	40 x 140 mm
	Asgat	30 mm
	Opgenomen vermogen	1.520 W
	Toerental onbelast	4.000 tr/min.
	L x B x H	775 x 625 x 610 mm
	Gewicht	19,5 kg

## C12LCHUTWZ

Afkortzaagmachine met standaard 712650

EAN 8717574061802



### Standaard toebehoren

1 zaagstandaard 712650 - 2 sleutels - 1 stofzak  
1 lengte aanslag - 1 zaagblad

### Technische specificaties



Diameter zaagblad	305 mm
Zaagcapaciteit	61,5 x 200 / 100 x 100 mm
Verstek 45°	61,5 x 140 mm
Kantel links 45°	40 x 200
Dubbel verstek 45°	40 x 140 mm
Asgat	30 mm
Opgenomen vermogen	1.520 W
Toerental onbelast	4.000 tr/min.
L x B x H	775 x 625 x 610 mm
Gewicht	19,5 kg

## C12LSHWA

Afkortzaagmachine

EAN 4966376141432



### Standaard toebehoren

1 sleutel - 1 stofzak - 1 lengte aanslag - 1 zaagblad

### Technische specificaties



Diameter zaagblad	305 mm
Zaagcapaciteit	107 x 312 mm / 120 x 260 mm
In verstek 45°	107 x 220 / 120 x 180 mm
Kantel links 45°	70 x 31 / 75 x 260 mm
Kantel rechts 45°	45 x 312 / 50 x 260 mm
Dubbel verstek links 45°	70 x 220 / 75 x 180 mm
Dubbel verstek rechts 45°	45 x 220 / 50 x 180 mm
Opgenomen vermogen	1.520 W
Toerental onbelast	4.000 tr/min.
L x B x H	930 x 595 x 710 mm
Gewicht	30 kg

## C12LSHWAS

Afkortzaagmachine met standaard 712650

EAN 8717574048339



### Standaard toebehoren

1 zaagstandaard 712650 - 1 sleutel - 1 stofzak - 1 zaagblad  
1 lengte aanslag

### Technische specificaties



Diameter zaagblad	305 mm
Zaagcapaciteit	107 x 312 mm / 120 x 260 mm
In verstek 45°	107 x 220 / 120 x 180 mm
Kantel links 45°	70 x 31 / 75 x 260 mm
Kantel rechts 45°	45 x 312 / 50 x 260 mm
Dubbel verstek links 45°	70 x 220 / 75 x 180 mm
Dubbel verstek rechts 45°	45 x 220 / 50 x 180 mm
Opgenomen vermogen	1.520 W
Toerental onbelast	4.000 tr/min.
L x B x H	930 x 595 x 710 mm
Gewicht	30 kg

## UU610CZ

Universeel standaard voor afkortzaagmachines

EAN 8717574002447



### Technische specificaties

	Totale lengte	2,35 m
	Gewicht	17,3 kg
	Max. Lading	225 kg

## 712650

Universeel standaard voor afkortzaagmachines

EAN 8717574043532

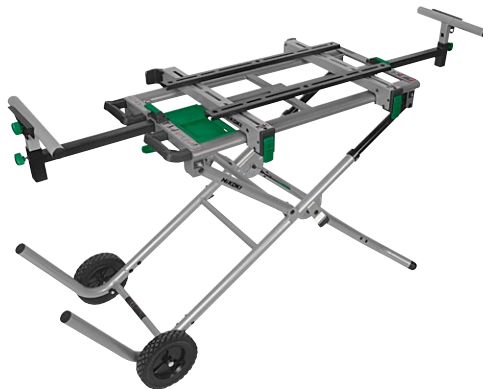

### Standaard toebehoren

set transport wielen

### Technische specificaties

	Totale lengte	1,42 m
	Gewicht	27,7 kg
	Max. Lading	136 kg

## CC14SFVAZ

Doorslijpmachine



EAN 4966376281404



### Standaard toebehoren

1 inbusleutel

### Technische specificaties

  	Diameter slijpschijf	355 mm
	Max. diam. ronde stalen buis	120 mm
	Max. diam. vierkante stalen buis	130 x 130 mm
	Max. diam. stalen staven	65 mm
	Asgat	25,4 mm
	Opgenomen vermogen	2.000 W
	Toerental onbelast	3.800 tr/min.
L x B x H	605 x 285 x 624 mm	
Gewicht	16,5 kg	

# Schaaf- en freesmachines





### P20SFWAZ

Schaafmachine

EAN 4966376296088



#### Standaard toebehoren

1 dopsleutel - 1 set HM messen - 1 beitel afstelmal  
1 breedte geleider

#### Technische specificaties

Schaafbreedte	82 mm
Sponningdiepte	9,0 mm
Spaandikte	2,6 mm
Opgenomen vermogen	620 W
Toerental onbelast	17.000 tr/min.
L x B x H	269 x 165 x 165 mm
Gewicht	2,5 kg



### P20SA2UAZ

Schaafmachine

EAN 4966376295616



#### Standaard toebehoren

1 dopsleutel - 1 set HM messen - 1 langsegeleider  
1 dieptegeleider

#### Technische specificaties

Schaafbreedte	82 mm
Sponningdiepte	25 mm
Spaandikte	3 mm
Opgenomen vermogen	720 W
Toerental onbelast	14.000 tr/min.
Lengte	309 mm
Gewicht	3 kg



### M12V2LAZ

Bovenfreesmachine

EAN 4966376295142



#### Standaard toebehoren

1 parallelaanslag - 1 staafhouder - 1 sjabloongeleider 18mm  
1 spantang 12 mm - 1 verloopbus 8 mm - 1 spangangelieder  
1 stofzuigadapter - 1 sleutel - 1 kunststof koffer

#### Technische specificaties

Freesdiepte	65 mm
Spindel	M14
Opgenomen vermogen	2.000 W
Toerental onbelast	8.000 - 22.000 tr/min.
Spantang	12 mm
Geluidsniveau	83 dB
Hoogte	255 - 320 mm
Gewicht	6,3 kg



## M12VEUTZ

Bovenfreesmachine

EAN 4966376295395



### Standaard toebehoren

1 parallelaanslag - 1 sjabloon geleider 18 mm  
1 sleutel 23 mm



### Technische specificaties

Freesdiepte	65 mm
Spindel	M14
Opgenomen vermogen	2.000 W
Toerental onbelast	8.000 - 22.000 tr/min.
Spantang	12 mm
Hoogte	229 - 300 mm
Gewicht	5,3 kg



## M8V2WSZ

Bovenfreesmachine

EAN 4966376295579



### Standaard toebehoren

1 parallelaanslag - 1 sjabloon geleider - 1 verloopbus  
1 sleutel - 1 stofzuigadapter - 1 kunststof koffer



### Technische specificaties

Freesdiepte	60 mm
Spindel	M14
Opgenomen vermogen	1.150 W
Toerental onbelast	11.000 - 25.000 tr/min.
Spantang	8 mm
Geluidsniveau	79 dB
Hoogte	232 - 292 mm
Gewicht	3,6 kg



## M8SA2LAZ

Bovenfreesmachine

EAN 4966376295470



### Standaard toebehoren

1 parallelaanslag - 1 sjabloon geleider - 1 verloopbus  
1 sleutel - 1 stofzuigadapter

### Technische specificaties

Freesdiepte	60 mm
Spindel	M14
Opgenomen vermogen	900 W
Toerental onbelast	25.000 tr/min.
Spantang	8 mm
Geluidsniveau	79 dB
Hoogte	232 - 292 mm
Gewicht	3,5 kg













## Schuurmachines

## SB10V2WAZ

Bandschuurmachine

EAN 4966376296613











	<b>Standaard toebehoren</b> 1 schuurband - 1 stofzak	
	<b>Technische specificaties</b>	
	Schuurband	610 x 100 mm
	Bandsnelheid onbelast	240 - 420 m/min.
	Opgenomen vermogen	1.020 W
	Geluidsniveau	88 dB
	L x B	363 x 189 mm
	Gewicht	5,2 kg

## SB8V2WAZ

Bandschuurmachine

EAN 4966376296798









	<b>Standaard toebehoren</b> 1 schuurband - 1 stofzak	
	<b>Technische specificaties</b>	
	Schuurband	533 x 76 mm
	Bandsnelheid onbelast	250 - 450 m/min.
	Opgenomen vermogen	1.020 W
	Geluidsniveau	87 dB
	L x B	318 x 171 mm
	Gewicht	4,3 kg

## SV12SDUAZ

Vlakschuurmachine

EAN 4966376279395



	<b>Standaard toebehoren</b> 1 schuurpapier - 1 stofzak	
	<b>Technische specificaties</b>	
	Schuurzool	228 x 114 mm
	Aantal schuurbewegingen	20.000 /min
	Opgenomen vermogen	300 W
	Toerental onbelast	10.000 tr/min.
	Geluidsniveau	76 dB
	Lengte	300 mm
	Gewicht	2,8 kg

### SV12SHWBZ

Vlakschuurmachine

EAN 4966376279753



**Standaard toebehoren**  
1 set schuurpapier - 1 stofzak



**Technische specificaties**

Schuurzool	110 x 190 mm
Opgenomen vermogen	200 W
Toerental onbelast	14.000 tr/min.
Geluidsniveau	82 dB
Hoogte	133 mm
Gewicht	1 kg



### SV12SGWBZ

Vlakschuurmachine

EAN 4966376279647



**Standaard toebehoren**  
1 set schuurpapier - 1 stofzak



**Technische specificaties**

Schuurzool	110 x 100 mm
Opgenomen vermogen	200 W
Toerental onbelast	14.000 tr/min.
Geluidsniveau	79 dB
Hoogte	137 mm
Gewicht	1,1 kg



### FSV10SALAZ

Vlakschuurmachine

EAN 4966376298570



**Standaard toebehoren**  
1 set schuurpapier - 1 stofzak



**Technische specificaties**

Schuurzool	184 x 92 mm
Aantal schuurbewegingen	20.000 /min.
Opgenomen vermogen	180 W
Toerental onbelast	10.000 tr/min.
Lengte	184 mm
Gewicht	1,3 kg



## SV15YCWZ

Excenter schuurmachine

EAN 4966376280162



### Standaard toebehoren

1 vel schuurpapier - 1 handgreep - 1 sleutel



### Technische specificaties

Schuurzool	150 mm
Opgenomen vermogen	350 W
Toerental onbelast	4.200 - 11.000 tr/min.
Geluidsniveau	82 dB
Hoogte	182 mm
Gewicht	2,5 kg



## SV13YAWZ

Excenter schuurmachine

EAN 4966376279920



### Standaard toebehoren

1 schuurpapier - 1 stofzak - 1 kunststof koffer



### Technische specificaties

Schuurzool	125 mm
Opgenomen vermogen	230 W
Toerental onbelast	7.000 - 12.000 tr/min.
Geluidsniveau	79 dB
Hoogte	145 mm
Gewicht	1,4 kg



## SV13YBWBZ

Excenter schuurmachine

EAN 4966376280117



### Standaard toebehoren

1 schuurpapier - 1 stofzak



### Technische specificaties

Schuurzool	125 mm
Opgenomen vermogen	230 W
Toerental onbelast	12.000 tr/min.
Geluidsniveau	79 dB
Hoogte	145 mm
Gewicht	1,35 kg



# Stofzuigers



## RP350YDHWAZ

Nat- en droogstofzuiger

EAN 4966376281060



### Standaard toebehoren

1 slang - 2 filters - 1 rubberen adapter - 1 afsluitdop  
stofzuigerkuip - 1 plastic stofzak

### Technische specificaties

Opgenomen vermogen	1.200 W
Luchtverplaatsing	3,6 m <sup>3</sup> /min.
Max. onderdruk	25 kPa
Inhoud voor stof	25 L
Inhoud voor water	22 L
Filterklasse	H
Diameter slang	35 mm
Lengte slang	5 m
L x B x H	550 x 550 x 400 mm
Gewicht	15,7 kg



## RP350YDMWAZ

Nat- en droogstofzuiger

EAN 4966376281077



### Standaard toebehoren

1 slang - 2 filters - 1 rubberen adapter - 1 afsluitdop  
stofzuigerkuip - 1 plastic stofzak

### Technische specificaties

Opgenomen vermogen	1.200 W
Luchtverplaatsing	3,6 m <sup>3</sup> /min.
Max. onderdruk	25 kPa
Inhoud voor stof	25 L
Inhoud voor water	22 L
Filterklasse	M
Diameter slang	35 mm
Lengte slang	5 m
L x B x H	550 x 550 x 400 mm
Gewicht	15,7 kg



## RP500YDMWAZ

Nat- en droogstofzuiger

EAN 4966376281138



### Standaard toebehoren

1 slang - 2 filters - 1 rubberen adapter - 1 afsluitdop  
stofzuigerkuip - 1 plastic stofzak

### Technische specificaties

Opgenomen vermogen	1.200 W
Luchtverplaatsing	3,6 m <sup>3</sup> /min.
Max. onderdruk	25 kPa
Inhoud voor stof	45 L
Inhoud voor water	40 L
Filterklasse	M
Diameter slang	35 mm
Lengte slang	5 m
L x B x H	960 x 595 x 465 mm
Gewicht	18 kg





## RP250YDMWAZ

Nat- en droogstofzuiger

EAN 4966376280971



### Standaard toebehoren

1 slang - 2 filters - 1 rubberen adapter - 1 afsluitdop  
stofzuigerkuip - 1 plastic stofzak

### Technische specificaties

Opgenomen vermogen	1.200 W
Luchtverplaatsing	3,6 m <sup>3</sup> /min.
Max. onderdruk	25 kPa
Inhoud voor stof	20 L
Inhoud voor water	16 L
Filterklasse	M
Diameter slang	35 mm
Lengte slang	5 m
L x B x H	430 x 490 x 390 mm
Gewicht	12,7 kg



## RP300YDLWAZ

Nat- en droogstofzuiger

EAN 4966376281053



### Standaard toebehoren

zuigslang dia. 32 mm en 3,5 m lengte met pistool  
2 metalen zuigbuis verlengstukken - vloerborstel-set  
(met vloerinzetstuk en inzetstuk voor natzuigen)  
platte zuigmond - adapter - ronde meubelborstel  
spleetzuigmond - haak - buishouder - PE-stofzak  
fleece stofzak

### Technische specificaties

Opgenomen vermogen	1.000 W
Luchtverplaatsing	3,6 m <sup>3</sup> /min.
Max. onderdruk	21 kPa
Inhoud	30 L
Filterklasse	L
Diameter slang	32 mm
Lengte slang	3,5 m
L x B x H	391 x 398 x 658 mm
Gewicht	9,2 kg



## RP250YDLWAZ

Nat- en droogstofzuiger

EAN 4966376280964



### Standaard toebehoren

zuigslang dia. 32 mm en 3,5 m lengte met pistool  
2 metalen zuigbuis verlengstukken - vloerborstel-set  
(met vloerinzetstuk en inzetstuk voor natzuigen)  
platte zuigmond - adapter - ronde meubelborstel  
spleetzuigmond - haak - buishouder - PE-stofzak  
fleece stofzak

### Technische specificaties

Opgenomen vermogen	1.000 W
Luchtverplaatsing	3,6 m <sup>3</sup> /min.
Max. onderdruk	21 kPa
Inhoud	25 L
Filterklasse	L
Diameter slang	32 mm
Lengte slang	3,5 m
L x B x H	374 x 392 x 550 mm
Gewicht	7,8 kg



## RB40VAUTZ

Blaas-zuigapparaat







EAN 4966376278350



### Standaard toebehoren

1 stofzak

### Technische specificaties

	Opgenomen vermogen	550 W
	Toerental onbelast	0 - 16.000 tr/min.
	Luchtverplaatsing	0 - 3,8 m <sup>3</sup> /min.
	Max. onderdruk	0 - 5,5 kPa
	Geluidsniveau	84 dB
	L x H	447 x 137 mm
	Gewicht	1,7 kg

# Overrig



## EC58LAZ

Compressor

EAN 4966376296897



### Technische specificaties

Opgenomen vermogen	750 W
Toerental	2.450 tr/min.
Luchtverplaatsing	0,16 m³/min.
Inhoud tank	6,0 L
Druk	8 bar
Geluidsniveau	68,4 dB Lpa 88,3 dB Lwa
L x B x H	460 x 275 x 410 mm
Gewicht	8,5 kg



L x B x H  
Gewicht

## RH650VLAZ

Heteluchtpistool

EAN 4966376278596



### Standaard toebehoren

5-delige toebehorenset - 1 kunststof koffer

### Technische specificaties

Opgenomen vermogen	2.000 W
Luchtstroom	250 - 500 L/min.
Werktemperatuur	50 - 650 °C
Neusdiameter	34,5 mm
L x B x H	245 x 85 x 254 mm
Gewicht	0,79 kg



L x B x H  
Gewicht

## RH600TLAZ

Heteluchtpistool

EAN 4966376278435



### Standaard toebehoren

5-delige toebehorenset - 1 kunststof koffer

### Technische specificaties

Opgenomen vermogen	2.000 W
Luchtstroom	250 - 500 L/min.
Werktemperatuur	250 - 600 °C
Neusdiameter	34,5 mm
L x B x H	245 x 83 x 250 mm
Gewicht	0,57 kg



L x B x H  
Gewicht

### CM75EBPWAZ

Motorslijpmachine 350 mm

EAN 4966376300259

**New  
PureFire**



#### Standaard toebehoren

1 zaagblad voor steen - 1 gereedschapset - 1 veiligheidsbril

#### Technische specificaties

Motortype	2-takt
Cilinderinhoud	75 cc
Inhoud brandstoftank	1.100 cc
Diameter slijpschijf	355 mm
Zaagdiepte	125 mm
Asgat	20 mm (25,4 met adepterring)
Toerental	4.200 tr/min.
Max. Power	3,9 Kw
Decompressieklep	Ja
Geluidsniveau	99,5 dB
L x B x H	630 x 225 x 420 mm
Gewicht	10,6 kg



### CM75EAPWAZ

Motorslijpmachine 305 mm

EAN 4966376300150

**New  
PureFire**



#### Standaard toebehoren

1 zaagblad voor steen - 1 gereedschapset - 1 veiligheidsbril

#### Technische specificaties

Motortype	2-takt
Cilinderinhoud	75 cc
Inhoud brandstoftank	1.100 cc
Diameter slijpschijf	305 mm
Zaagdiepte	100 mm
Asgat	20 mm (25,4 met adepterring)
Toerental	4.200 tr/min.
Max. Power	3,9 Kw
Decompressieklep	Ja
Geluidsniveau	99,5 dB
L x B x H	630 x 225 x 394 mm
Gewicht	10,4 kg



### AW150LAZ

Hogedrukreiniger

EAN 4966376297696



#### Standaard toebehoren

1 spuitpistool - 1 hoge druk slang (10m) - 1 variabel spuitstuk (met drukregelaar) - 1 turbo spuitstuk - 1 wasmiddel flacon  
1 klikverbinding voor gebruik met de sproeimond  
1 wateraansluiting - 1 reinigingspin - 1 spuitstuk houder  
1 handvat - 1 spuitstuk steun

#### Technische specificaties

Opgenomen vermogen	2.000 W
Werkdruk	110 bar
Max. toegestane druk	150 bar
Debiet / waterverbruik	6,67 L/min.
Hogedrukslang	10 m
L x B x H	425 x 345 x 905 mm
Gewicht	12,4 kg



### AW130LAZ

Hogedrukreiniger

EAN 4966376297597



#### Standaard toebehoren

1 spuitpistool - 1 hoge druk slang (10m) - 1 variabel spuitstuk (met drukregelaar) - 1 turbo spuitstuk - 1 wasmiddel flacon  
1 klikverbinding - 1 wateraansluiting - 1 reinigingspin  
1 snoersteun - 1 handvat

#### Technische specificaties

Opgenomen vermogen	1.600 W
Werkdruk	90 bar
Max. toegestane druk	130 bar
Max. Aanvoer druk	7 bar
Hogedrukslang	10 m
L x B x H	325 x 260 x 790 mm
Gewicht	8,3 kg



### AW100LAZ

Hogedrukreiniger

EAN 4966376297474



#### Standaard toebehoren

1 spuitpistool - 1 hoge druk slang (5 m) - 1 variabel spuitstuk (met drukregelaar) - 1 wasmiddel flacon - 1 wateraansluiting  
1 reinigingspin - 1 snoersteun - 1 pistoolsteun - 1 handvat

#### Technische specificaties

Opgenomen vermogen	1.400 W
Werkdruk	70 bar
Max. toegestane druk	100 bar
Max. Aanvoer druk	7 bar
Hogedrukslang	5 m
L x B x H	305 x 245 x 465 mm
Gewicht	5,4 kg



# HiKOKI System Case



## Jouw gereedschap, perfect beschermd.

Goed gereedschap, daar ben je natuurlijk zuinig op. Speciaal daarom heeft HiKOKI de HSC koffers ontwikkeld: de HiKOKI System Case. Dit opbergsysteem is zo ontworpen dat vrijwel elke machine past in één van de vier basiskoffers dankzij de multifunctioneel gevormde inlay en machinehouders. Hier is uiteraard ook rekening gehouden met ruimte voor accessoires.

HiKOKI System Cases worden geleverd in vier verschillende hoogtematen. Volledig stapelbaar en aan elkaar te koppelen voor extra stevigheid tijdens bijvoorbeeld het transport. En om het nog gemakkelijker te maken, is er ook een onderstel met draaibare wielen verkrijgbaar. Onderweg of op locatie; jouw gereedschap is altijd perfect beschermd.

Soort	Past in	Bestelnr.	EAN
HiKOKI System Case I leeg	HSC I	402544	4549115077560
HiKOKI System Case II leeg	HSC II	402545	4549115077577
HiKOKI System Case III leeg	HSC III	402546	4549115077584
HiKOKI System Case IV leeg	HSC IV	402547	4549115077591
Afsluiting koffer	HSC	336472	4549115054240
Box set groen (3 stuks)	HSC I	402542	4549115077546
Handgreep	HSC	336473	4549115054257
Inleg M8V2	HSC IV	337763	4549115084841
Inleg DH36DBL	HSC IV	370330	4549115128538
Inleg + box set groen	HSC I	337746	4549115084537
Opbergbox rood	HSC I	711240	8717574047233
Opbergbox geel	HSC I	711241	8717574047240
Opbergbox blauw	HSC I	711242	8717574047257
Opbergbox groen	HSC I	711243	8717574047264
Plastic inleg CJ14DSL / CJ18DSL	HSC III	337110	4549115072916
Plastic inleg CJ14DSL / CJ18DSL	HSC III	337111	4549115072923

Soort	Past in	Bestelnr.	EAN
Plastic inleg CV350V	HSC II	337937	4549115090927
Plastic inleg decoupeerzaag	HSC I	337740	4549115083943
Plastic inleg DH24 / 26 / 28	HSC I	337741	4549115083950
Plastic inleg DH18DSL	HSC II	337114	4549115072954
Plastic inleg DN14DSL / DN18DSL	HSC II	337288	4549115075214
Plastic inleg G14DSL / G18DSL	HSC II	337113	4549115072947
Plastic inleg SV13YA	HSC III	337764	4549115084858
Plastic inleg WF18DSL	HSC III	337112	4549115072930
Scharnierpin	HSC	336474	4549115054264
Schuim inleg P20SF	HSC III	337742	4549115083967
Schuim inleg WR18DSSL	HSC III	337109	4549115072909
Schuim inleg C7UY	HSC IV	337658	4549115081802
Schuim inleg C6U2 / C7U2 / C6BU2 / C7BU2	HSC IV	337659	4549115081819
Schuim inleg C18DSL	HSC IV	337529	4549115079540
Spanrubber	HSC	337743	4549115084506



## 402538

HSC I met schuim inleg  
EAN 4549115077508



## 402543

Onderstel met draaibare wielen  
EAN 4549115077553



## 402539

HSC II met schuim inleg  
EAN 4549115077515



## 337941

Plastic inleg voor 10,8 V machines (HSC I)  
EAN 4549115088726



## 402540

HSC III met schuim inleg  
EAN 4549115077522



## 336475

Plastic inleg voor 14 / 18 V boor-schroefmachines (HSC II)  
EAN 4549115055056



## 402541

HSC IV met schuim inleg  
EAN 4549115077539



## 715699

Plastic inleg voor twee 18 V machines (HSC IV)  
EAN 8717574048636



# Stofafzuiging



# Stofvrij werken, waar je ook bent.

Bij HiKOKI vinden we de werkomstandigheden voor jou als pro-fessional ontzettend belangrijk. Daarom denken we tot in detail na over hoe we al jouw werkzaamheden zo comfortabel, maar ook veilig mogelijk kunnen maken.

Iedere professional heeft ermee te maken, stof. En er komt nogal wat stof vrij als je aan het boren, hakken, slijpen, schuren of zagen bent.

Voor ieder project, binnen of buiten, hebben we bij HiKOKI de juiste en veiligste stofafzuigingsystemen/-accessoires en stofkappen.

Onderstaand vind je een overzicht van een selectie van onze afzuigsystemen en -accessoires, zodat je altijd en overal stofvrij kunt werken.

Soort	Bestel nr.	EAN
Aansluitring haakse slijpmachine 125 mm G13SB3	783107	8717574044126
Aansluitring haakse slijpmachine 125 mm < 800 W	783113	8717574048988
Aansluitring accu haakse slijpmachine 125 mm G18DBL	783106	8717574058147
Stofbox met arbokap 125 mm	783120	8717574053937
Universele stofkap incl. wartel SDS-MAX hamers H45MEY / H60MEY	783121	8717574058017
Afzuigadapter boren MAX 14 mm	783116	8717574051292
Afzuigadapter boren incl. wartel MAX 90 mm	783122	8717574058246
Afzuigadapter boren incl. wartel MAX 180 mm	783123	8717574058253
Adapter stofkap hamers voor H65SB2 en 783121	783115	8717574049572
Rubber mondstuk voor 783121	783114	8717574048995
Stofkap haakse slijpmachine 125 mm zachtsteen	783102	8717574044096
Stofkap haakse slijpmachine 125 mm natuursteen	783104	8717574044119
Universele aansluit wartel 38 mm	783109	8717574044157
Stofmaskers FFP2 + ademventiel (2 stuks)	750409	8717574041286

# HiKOKI

## HiKOKI Power Tools Netherlands B.V.

Brabanthaven 11, 3433 PJ Nieuwegein  
Postbus 2310, 3430 DN Nieuwegein

**Tel.** Algemeen: 030-608 40 40

Verkoop: 030-608 40 50

**Fax** Verkoop: 030-606 72 66

[verkoop@hikoki-powertools.nl](mailto:verkoop@hikoki-powertools.nl)

## HiKOKI Power Tools Belgium N.V./S.A.

Koningin Astridlaan 51, 1780 Wemmel

**Tel.** 02/4601720

**Fax** 02/4602542

[info@hikoki-powertools.be](mailto:info@hikoki-powertools.be)

**Volg ons ook op social media en  
mis helemaal niets meer van HiKOKI**



**[hikoki-powertools.nl](http://hikoki-powertools.nl)**  
**[hikoki-powertools.be](http://hikoki-powertools.be)**

## Koki Holdings Co., Ltd.

Shinagawa Intercity Tower A, 20th floor15-1,  
Konan 2-chome, Minato-ku, Tokyo 108-6020, Japan

**Tel.** +81-3-5783-0601

**Fax** +81-3-5783-0709

[www.koki-holding.com](http://www.koki-holding.com)